

PULS

DIN-RAIL POWER SUPPLIES



PRODUCTS  
2009-2010



## SUCCESS WITH INNOVATION AND QUALITY

QUALITY INNOVATION

PULS is the only organisation solely focused on the design and manufacturing of DIN-Rail power supplies for industrial applications. This allows Bernhard Erdl and his experienced team to develop premium pioneered products.

Smallest sizes, industry leading efficiencies, easy integration in machines and systems, comprehensive datasheets, excellent overload behaviour, are only some of the strong features which make us the leader in technology for DIN-rail power supplies.

The success story with PULS DIN-rail power supplies started with the SilverLine units, which were launched over 12 years ago. This great success has continued with the MiniLine and DIMENSION units. The versatile utilizations in various fields of application of our power supplies as well as the international honours such as the Frost & Sullivan Technology Leadership Award confirm that PULS is on the right track.

PULS R&D departments are located in Germany. The high quality of the units is ensured by the company's own factories in the Czech Republic and China.

If you cannot find a standard unit for your needs in the current range of PULS products, then please contact our subsidiary company MGV. MGV has been a member of the PULS Group since 2004 and the MGV team will be happy to help with customised solutions.

# OUR STRONG POINTS

## Small

PULS power supplies are at the forefront of the market with the smallest and most powerful units for their size. The dimensions are as much as 50% smaller than other standard products which enables significant space reductions in control cabinets and machines. Be creative and take advantage of these new possibilities.

Until now, the efficiency of our units has been unrivalled due to minimal losses and our state-of-the-art technology. This basic requirement is essential to achieve small size without compromising in quality or reliability. We also guarantee high MTBF and long life expectancy figures as well as offering three year warranty.



The small footprint enables large space reductions allowing you to be creative and take advantage of new possibilities.

## Powerful

Large power reserves support the starting of heavy loads such as DC-motors or capacitive loads. With PULS, power supplies no longer have to be oversized to accommodate short-term peak loads of dynamic current demands.

Depending on the series, PULS guarantees BonusPower® of 50% or a Power Boost up to 25%. For the DIMENSION C-Series this extra current can be handled continuously for ambient temperatures below 45°C. With these power reserves, the user does not need to oversize but simply chooses a unit which meets the operating requirements. In some cases, a smaller unit can be selected saving both money and space.

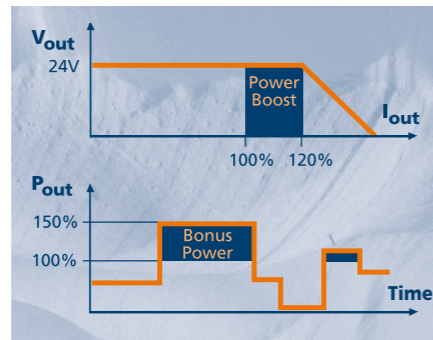

Generous power reserves for loads with dynamic current demands. In many cases, you can rely on the next smaller unit which can save you money.

## Easy

All signals and control elements are straightforward, self explanatory and easily accessible. The patented DIN-rail system and spring clamp terminals do not require tools and make the installation effortless.

Wide range or auto-select input voltages avoid user errors. The wide operating temperature range and the extraordinary EMI immunity enables trouble free operation, even under harsh conditions.

With an extensive approval package, universal input voltages and worldwide support, choosing PULS power supplies is made easy around the globe.



For a secure connection: Vibration proof quick-connect spring-clamp terminals, no tools required.

# CONTENT

<b>1</b>	Product Overview.....	6-9
<b>2</b>	New Products .....	10-11
<b>3</b>	1-Phase Power Supplies.....	12-21
	24V Output Voltage .....	12-17
	Additional Output Voltages .....	18-21
<b>4</b>	3-Phase Power Supplies.....	23-27
	24V Output Voltage .....	23-25
	Additional Output Voltages .....	26-27
<b>5</b>	DC/DC Converter .....	29-31
	Input Voltage 88-375Vdc and 360-900Vdc .....	29
	Input Voltage 12Vdc, 24Vdc, 48Vdc.....	30-31
<b>6</b>	Power Supplies for AS-Interface® Systems .....	32-33
<b>7</b>	DC UPS's, Battery Modules and Buffer Modules.....	34-39
<b>8</b>	Redundancy and Diode Modules.....	40-41
<b>9</b>	Standards and Approvals .....	42-45
<b>10</b>	Technical Notes .....	47-51
	Protection of 24V Branches with Circuit Breakers .....	47
	Power Supplies for DeviceNet® Systems .....	47
	Characteristics of Semi-Regulated Power Supplies.....	48
	Mains Voltages Worldwide.....	48
	Conformal Coated Power Supplies .....	49
	Series Connections of Outputs .....	49
	Parallel Connections of Outputs .....	50
	Mounting Accessories .....	51
	Using only Two Legs of the Three Phase System .....	51

# OUR PRODUCT FAMILIES



## SilverLine

The classic power supply family for general applications which has been proven over a million times. They will be gradually augmented by the DIMENSION series.

- Single- or three-phase-input
- Redundant power supplies
- AS-Interface® power supplies



## MiniLine

The MiniLine series covers the lower power requirements in the range from 15W to 100W. The units in their rugged plastic housing are highly efficient, compact, can be installed in seconds and are extremely reliable. Apart from the standard 24V power supplies, many other output voltages are also available.

- Single-phase or 400/480V input
- Robust plastic housing
- Wide temperature range from -10°C to +60°C
- Output voltages from 5V to 56V
- Quick-connect spring-clamp terminals
- Diode module for redundancy

	1-Phase Supplies	3-Phase Supplies	DC/DC Converter	DC-UPS	Buffer-modules	Redundancy and Diode Modules
MiniLine	15-100W	90-100W	-	-	-	10A
SilverLine	60-240W	120-960W	40W	-	24V	2.5-40A
DIMENSION C-Series	80-240W	96-240W	92-120W	-	-	-
Q-Series	80-960W	480-960W	480W	-	-	-
X-Series	-	960W	-	-	-	-
U-Series	-	-	-	10A	24V, 48V	-
Y-Series	-	-	-	-	-	20A



## DIMENSION

DIMENSION offers you everything – from basic units with only essential functions to premium products for more demanding applications. Other DIMENSION units offer semi-regulation, buffer modules, DC-UPS's and a larger assortment of accessories. Thanks to the wide variety of options, you only pay for the features you need.

### C-Series: Power Supplies and DC/DC Converters

For users looking for highly reliable power supplies in a compact housing which are easy to use. Focusing only on the essentials achieves significant price advantages.

- 20% Power reserves
- Low inrush current surge
- Large screw connection terminals

### X-Series: Semi-regulated 3-Phase Power Supplies

For motors and other power-hungry loads. Small size, maximum efficiency, low price are the benefits with only minor compromises in output voltage regulation precision and buffer time.

- 25% Power reserves
- No inrush current surge
- Efficiencies up to 96%

### Y-Series: Diode- and Redundancy Modules

For building redundant power supply systems or to isolate sensitive circuits.

- Redundancy modules with alarm contacts
- Diode modules without alarm contacts

### Z-Series: Mounting Accessories

For installation in low profile cabinets or for panel installations where no DIN-rail is available.

### Q-Series: Premium Class Power Supplies

Suitable when you need state-of-the-art technology and flexibility for demanding tasks. With outstanding efficiencies, 50% BonusPower® and many other features, this series is the "Best in Class".

- 50% Power Reserves
- AC and DC wide-range input
- Low inrush current surge
- DC-OK relay contact (except QS3)
- Excellent power factor
- Active power factor correction (PFC)
- Active filter against input transients
- Quick-connect spring-clamp terminals
- Extensive approval package

### U-Series: Bridging of Power Outages

Back-up systems: for minutes with a DC-UPS needing only one 12V-battery or for seconds with our battery-free buffer module. This improves safety and prevents downtime, loss of data and long restart sequences.

# Product Overview

## Preferential Products

### 1-Phase Power Supplies

			Page	Output	Input	Special Features
5V	3A	ML15.051	18	5-5.5V	AC 100-240V	
	5A	ML30.101	18	5-5.5V	AC 100-240V	
12V	1.3A	ML15.121	18	12-15V	AC 100-240V	
	2.5A	ML30.102	18	10-12V	AC 100-240V	very low output noise
	4.2A	ML50.102	18	12-15V	AC 100-240V	
	7.5A	ML100.102	19	12-15V	AC 115/230V	
	15A	QS10.121	19	12-15V	AC 100-240V	
±12V	1.5A	ML30.106	19	±12-15V	AC 100-240V	dual-output voltage
24V	0.63A	ML15.241	12	24-28V	AC 100-240V	
	1.3A	ML30.100	12	24-28V	AC 100-240V	
	2.1A	ML50.100	12	24-28V	AC 100-240V	
	2.1A	ML50.109	12	24-28V	AC 100-240V	conformal coated
	2.1A	ML50.101	12	24-28V	AC 100-240V	optimized for parallel use
	2.1A	ML50.111	12	24-28V	AC 100-240V	with screw terminals
	2.5A	SL2.100	12	24V	AC 115/230V	
	2.5A	SLR2.100	12	24V	AC 115/230V	for redundant applications
	3A	ML70.100	14	24-28V	AC 115/230V	
	3.3A	CS3.241	14	24-28V	AC 100-240V	
	3.4A	QS3.241	14	24-28V	AC 100-240V	
	3.8A	QS5.DNET	14	24V	AC 100-240V	DeviceNet® approved
	3.9A	ML95.100	14	24-28V	AC 115/230V	NEC Class 2
	4.2A	ML100.100	15	24-28V	AC 115/230V	
	4.2A	ML100.109	15	24-28V	AC 115/230V	conformal coated
	5A	CS5.241	15	24-28V	AC 115/230V	
	5A	CS5.241-C1	15	24-28V	AC 115/230V	conformal coated
	5A	CS5.241-S1	15	24-28V	AC 115/230V	spring-clamp terminals
	5A	CS5.243	15	24-28V	AC 100-120V	
	5A	CS5.244	15	24-28V	AC 200-240V	
	5A	QS5.241	15	24-28V	AC 100-240V	
	5A	SL5.100	15	24V	AC 115/230V	
	5A	SLR5.100	15	24V	AC 115/230V	for redundant applications
	8A	QS10.DNET	16	24-24.5V	AC 100-240V	DeviceNet® approved
	10A	CS10.241	16	24-28V	AC 115/230V	
	10A	CS10.241-S1	16	24-28V	AC 115/230V	spring-clamp terminals
	10A	CS10.242	16	24-28V	AC 115/230V	with PFC inductor
	10A	CS10.243	16	24-28V	AC 100-120V	
	10A	CS10.244	16	24-28V	AC 200-240V	
	10A	QS10.241	17	24-28V	AC 100-240V	
	10A	QS10.241-C1	17	24-28V	AC 100-240V	conformal coated
	10A	SL10.100	17	24-28V	AC 115/230V	
	10A	SLR10.100	17	24V	AC 115/230V	for redundant applications
	20A	QS20.241	17	24-28V	AC 100-240V	
	20A	QS20.241-C1	17	24-28V	AC 100-240V	conformal coated
	20A	QS20.244	17	24-28V	AC 200-240V	
	40A	QS40.244	17	24-28V	AC 200-240V	
30V	8A	QS10.301	20	28-32V	AC 100-240V	
36V	13.3A	QS20.361	20	36-42V	AC 100-240V	
48V	1.05A	ML50.105	20	48-56V	AC 100-240V	
	2.1A	ML100.105	20	48-56V	AC 115/230V	
	5A	CS10.481	20	48-52V	AC 115/230V	
	5A	QS10.481	21	48-56V	AC 100-240V	
	10A	QS20.481	21	48-55V	AC 100-240V	

# Product Overview

### Power Supplies for the 3-Phase System

			Page	Output	Input	Special Features
12V	8A	CT5.121	26	12-15V	2AC 380-480V	
24V	3.75A	ML90.200	23	24-28V	2AC 380-480V	
	4.2A	ML100.200	23	24-28V	2AC 380-480V	
	5A	CT5.241	23	24-28V	2AC 380-480V	
	5A	SL5.300	23	24-28V	3AC 400-500V	
	10A	CT10.241	24	24-28V	3AC 380-480V	
	10A	SL10.300	24	24-28V	3AC 400-500V	
	10A	SL10.309	24	24-28V	3AC 400-500V	conformal coated
	20A	QT20.241	24	24-28V	3AC 380-480V	
	20A	QT20.241-C1	24	24-28V	3AC 380-480V	conformal coated
	20A	SL20.310	24	24-28V	3AC 400-500V	
	40A	QT40.241	24	24-28V	3AC 380-480V	
	40A	SL40.301	25	24-28V	3AC 400-500V	with signal contacts
	40A	XT40.241	25	24-28V	3AC 400V	semi-regulated
	40A	XT40.242	25	24-28V	3AC 480V	semi-regulated
36V	13.3A	QT20.361	26	36-42V	3AC 380-480V	
	26.6A	XT40.361	26	36V	3AC 400V	semi-regulated
	26.6A	XT40.362	26	36V	3AC 480V	semi-regulated
48V	5A	CT10.481	26	48-56V	3AC 380-480V	
	10A	QT20.481	26	48-55V	3AC 380-480V	
	20A	QT40.481	27	48-55V	3AC 380-480V	
	20A	XT40.481	27	48V	3AC 400V	semi-regulated
	20A	XT40.482	27	48V	3AC 480V	semi-regulated
72V	13.3A	XT40.721	27	72V	3AC 400V	semi-regulated
	13.3A	XT40.722	27	72V	3AC 480V	semi-regulated

### AS-Interface® Power Supplies

30.6V	2.8A	SLA3.100	32	30.6V	AC 115/230V	
	4A	SLA4.100	32	30.6V	AC 115/230V	with ground-fault monitor
	8A	SLA8.100	32	30.6V	AC 115/230V	
	8A	SLA8.300	32	30.6V	3AC 400-500V	
	4A	SLAD4.100	32	30.6V	DC 24V	DC/DC converter

### DC/DC Converters

5V	8A	SLD2.100	30	5-5.5V	DC 24V	
12V	8A	CD5.121	30	12-15V	DC 24V	
24V	3.8A	CD5.241-L1	30	24V	DC 24V	NEC Class 2
	4A	CD5.243	30	24-28V	DC 12V	
	5A	CD5.241	30	24-28V	DC 24V	
	5A	CD5.241-S1	31	24-28V	DC 24V	with signal contacts
	5A	CD5.242	31	24-28V	DC 48V	
	20A	QTD20.241	29	24-28V	DC 600V	for intermediate DC-bus

### Redundancy and Diode Modules

		MLY02.100	40	10-60V, 2x5A	dual-input diode decoupling module
		YR2.DIODE	40	10-60V, 2x10A	dual-input diode decoupling module
		YRM2.DIODE	40	24-60V, 2x10A	dual-input redundancy module
		SLR01	40	24-28V, 1x40A	single-input redundancy module
		SLR02	40	24-28V, 2x30A	dual-input redundancy module

### DC-UPS and Buffer Modules

		UB10.241	34	24V, 10A	DC-UPS control unit for ext. batteries 3.9-40Ah
		UB10.242	34	24V, 10A	DC-UPS control unit for ext. batteries 17-130Ah
		UB10.245	35	24V, 10A	DC-UPS with additional 12V output
		UBC10.241	34	24V, 10A	DC-UPS with integrated 5Ah battery
		UZK12.071	37	12V, 7Ah	battery module for DC-UPS
		UZK12.261	37	12V, 26Ah	battery module for DC-UPS
		SLV20.200	38	24V, 20A	capacitor buffer module, typ. 310ms at 20A
		UF20.241	38	24V, 20A	capacitor buffer module, typ. 310ms at 20A
		UF20.481	38	48V, 20A	capacitor buffer module, typ. 150ms at 20A

### SLAD4.100



**DC/DC Converter for AS-Interface®**  
 Aside from AS-Interface® power supplies for 1- and 3-phase systems, a 4A DC/DC converter is now available. This converter is simply powered from the 24V-bus and avoids hazardous power line voltages on systems and machines. The SLAD4.100 provides the AS-Interface® voltage of 30.6V and already incorporates the required data decoupling circuit.  
 See page 32.

<b>Input</b>	DC 24V
<b>Output</b>	AS-i 30.6V, 4A
<b>WxHxD</b>	40x124x102mm

### UBC10.241



Battery Inside

**DC-UPS with integrated battery**  
 The UBC10 has the required single battery included and is a compact addition to our DC-UPS line. This saves space, minimises wiring effort and avoids wiring errors during installation. Perfect for cabinets and panels which do not get warmer than +40°C.  
 See page 34.

<b>Input</b>	DC 24V
<b>Output</b>	24V, 10A (15A)
<b>Battery</b>	12V, 5Ah included
<b>Buffer Time</b>	typ. 6 minutes
<b>WxHxD</b>	123x124x119mm

### ML15



**Excellent cost/performance ratio: MiniLine with 15 Watt**  
 For low-power requirements, three new units have been added to the MiniLine family. With a width of only 22.5mm, three different output voltages are now available.  
 See pages 12 and 18.

<b>Input</b>	AC 100-240V
<b>Output</b>	5V, 12-15V or 24-28V
<b>Temperature</b>	-10°C to +60°C
<b>WxHxD</b>	22,5x75x91mm

### UB10.245

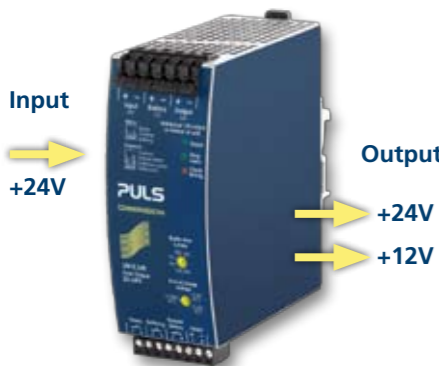

**Input**  
 +24V

**Output**  
 +24V  
 +12V

**24V DC-UPS with an additional 12V output**  
 For applications requiring supply voltages of 12V and 24V, a very simple-to-use dual output unit has been designed. With just one DC-UPS and one single battery, both output voltages can be provided during normal operation and in the event of power failures.  
 See page 35.

<b>Input</b>	DC 24V
<b>Output</b>	24V, 10A and 12V, 5A
<b>Total Power</b>	max. 240W
<b>WxHxD</b>	49x124x119mm

# NEW PRODUCTS 2009

### Two new power supplies for 3-phase-systems

Two new DIMENSION power supplies extend the choice of available units for 3-phase systems in the lower power range. With a width of only 40mm for the 120W and 62mm for the 240W power supply, these two units are extremely small compared to the current market standard.  
 See pages 23 and 24.

<b>Input</b>	CT5: 2AC 380-480V CT10: 3AC 380-480V
<b>Output</b>	12-15V, 24-28V or 48-56V
<b>WxHxD</b>	CT5: 40x124x117mm CT10: 62x124x117mm

### CT5, CT10



CT5: 40mm  
 CT10: 62mm

### 960W DIMENSION 1- and 3-phase power supplies

All the winning features of the Q-Series are now also available in 40A versions. The DIMENSION 3-phase units only require 110mm and the 1-phase unit 125mm space on the DIN-rail. These dimensions set a new benchmark in DIN-rail space requirements.  
 See pages 17, 25 and 27.

<b>Input</b>	QS: AC 200-240V QT: 3AC 380-480V
<b>Output</b>	24-28V or 48-55V
<b>WxHxD</b>	QS: 125x124x117mm QT: 110x124x117mm

### QS40, QT40



QS40: 125mm  
 QT40: 110mm

### Versatile 120W DC/DC Converter

A whole new series of DC/DC converters for the DIN-rail is now available in the DIMENSION series. All DC/DC converters have a galvanically isolated output and are specified with full output power in the temperature range from -25°C to +60°C.  
 See pages 30 and 31.

	Input	Output
<b>CD5.121</b>	18-32.4V	12-15V, 96W
<b>CD5.241</b>	18-32.4V	24-28V, 120W
<b>CD5.242</b>	36-60V	24-28V, 120W
<b>CD5.243</b>	8.4-16.2V	24-28V, 96W
<b>CD5.241-S1*</b>	18-32.4V	24-28V, 120W
<b>CD5.241-L1**</b>	14-32.4V	24-28V, 92W

\* Spring-clamp terminals, DC-OK and Input-Low-signal  
 \*\* NEC-Class-2 approved

### CD5





## 24V Power Supplies for 1-Phase-Systems

PULS offers the largest product range of 24V DIN-rail power supplies. The various features and output powers of the individual units allow for optimal selection for a wide range of applications and requirements. Choose a suitable power supply from the three product families MiniLine, SilverLine and Dimension.

1-Phase Power Supplies		15W	30W	50W		60W	
Output: 24V		0.63A	1.3A	2.1A	2.1A	2.5A	2.5A
Family		MiniLine	MiniLine	MiniLine	MiniLine	SilverLine	SilverLine
Output Voltage	nom.	24-28V	24-28V	24-28V	24-28V	24V	24V
Output Current	continuous nom.	0.63-0.54A	1.3-1.1A	2.1-1.8A	2.1-1.8A	2.5A	2.5A
Output Current	short-term	-	-	-	-	-	-
Output Power	continuous nom.	15W	30W	50W	50W	60W	60W
Output Power	short-term	-	-	-	-	-	-
Power Reserves	min.	-	-	-	-	-	-
Factory Setting <sup>1)</sup>	typ.	24.5V	24.5V	24.5V	24.0V	24.5V	24.0V
Ripple & Noise Voltage <sup>2)</sup>	max.	50mVpp	50mVpp	50mVpp	50mVpp	25mVpp	30mVpp
Overload Behaviour		Hiccup-mode	cont. current	cont. current	cont. current	cont. current	cont. current
AC Input Voltage	nom.	AC 100-240V -15%/+10%	AC 100-240V -15%/+10%	AC 100-240V -15%/+10%	AC 100-240V -15%/+10%	AC 100-120V/ 200-240V #) -15%/+10%	AC 100-120V/ 200-240V #) -15%/+10%
Input Current <sup>3)</sup>	max.	0.3A	0.6A	1.0A	1.0A	1.3/0.7A	1.3/0.7A
Harmonic Correction <sup>8)</sup>		-	-	-	-	-	-
EN 61000-3-2 (PFC Norm)		no	no	no	no	no	no
Power Factor 120/230Vac <sup>1)</sup>	typ.	0.51/0.44	0.61/0.53	0.56/0.52	0.56/0.52	0.6/0.51	0.6/0.51
Hold-Up Time 120/230Vac <sup>1)</sup>	typ.	47/196ms	46/200ms	40/180ms	40/180ms	53/54ms	53/54ms
Input Inrush Current Limiter		NTC	NTC	NTC	NTC	NTC	NTC
Input Inrush Current 120Vac <sup>5)</sup>	typ.	13A; 0.1A <sup>2s</sup>	17A; 0.3A <sup>2s</sup>	17A; 0.4A <sup>2s</sup>	17A; 0.4A <sup>2s</sup>	15A; 1.1A <sup>2s</sup>	15A; 1.1A <sup>2s</sup>
Input Inrush Current 230Vac <sup>5)</sup>	typ.	26A; 0.4A <sup>2s</sup>	35A; 1.1A <sup>2s</sup>	35A; 1.5A <sup>2s</sup>	35A; 1.5A <sup>2s</sup>	28A; 1.6A <sup>2s</sup>	28A; 1.6A <sup>2s</sup>
External Input Circuit Breaker <sup>4)</sup>	min.	B-6A; C-3A	B-10A; C-6A	B-10A; C-6A	B-10A; C-6A	B-10A; C-6A	B-10A; C-6A
DC Input Voltage	nom.	DC 110-300V <sup>5) T)</sup> -20%/+25%	DC 110-300V <sup>5) T)</sup> -20%/+25%	DC 110-300V <sup>5) T)</sup> -20%/+25%	DC 110-300V <sup>5) T)</sup> -20%/+25%	DC 200-300V <sup>5) T)</sup> -20%/+25%	DC 200-300V <sup>5) T)</sup> -20%/+25%
Efficiency 120/230Vac <sup>1)</sup>	typ.	86.1/85.1%	87.0/87.5%	88.4/89.0%	88.4/89.0%	87.8/89.1%	86.1/87.2%
Power Losses 120/230Vac <sup>1)</sup>	typ.	2.5/2.7W	4.5/4.3W	6.6/6.2W	6.6/6.2W	8.3/7.3W	9.7/8.8W
MTBF <sup>6)</sup>	typ.	4369 kh	3603 kh	2613 kh	2613 kh	2575 kh	2301 kh
Operational Temperature Range	min.	-10°C to +70°C	-10°C to +70°C	-10°C to +70°C	-10°C to +70°C	-10°C to +70°C	-10°C to +70°C
Derating +60°C to +70°C	min.	0.4W/°C	0.8W/°C	1.3W/°C	1.3W/°C	1.5W/°C	1.5W/°C
Dimensions WxHxD <sup>7)</sup>	nom.	22.5x75x91mm	45x75x91mm	45x75x91mm	45x75x91mm	49x124x102mm	49x124x102mm
Connection Terminals		screw terminals	spring terminals	spring terminals	spring terminals <sup>*)</sup>	screw terminals	plug connectors
Weight	max.	130g	230g	240g	240g	460g	470g
DC-OK-Signal		no	no	yes <sup>O)</sup>	yes <sup>O)</sup>	no	yes <sup>P)</sup>
Parallel Use		yes <sup>M)</sup>	yes <sup>M)</sup>	yes <sup>M)</sup>	yes	yes <sup>M)</sup>	yes
Series Connection <sup>9)</sup>		yes	yes	yes	yes	yes	yes
Bracket for Wall/Panel Mounting		-	included	included	included	SLZ02	SLZ02
Bracket for Side Mounting		-	-	-	-	-	-
Special Features					optimized for parallel use		redundant unit, decoupling diode
Order Number		ML15.241	ML30.100	ML50.100 ML50.109 <sup>*)</sup>	ML50.101 ML50.111 <sup>*)</sup>	SL2.100	SLR2.100

\*) ML50.109 with conformal coated PC-board, ML50.111 with screw terminals (plug connector,) depth 98mm, #) Manual-select by slide-switch  
Fold out the back page to find the appropriate footnotes.  
Information regarding standards and approvals can be found on pages 42 to 44.  
Visit [www.pulspower.com](http://www.pulspower.com) for detailed datasheets.



#### DIMENSION C-Series

100-120V	200-240V	
✓	✓	CS5.241 CS10.241
✓	✓	CS5.244 CS10.244
✓	✓	CS5.243 CS10.243

Save money:  
For specific regions, use the optionally available units with only a 120V or 230V input.

#### DIMENSION Q-Series

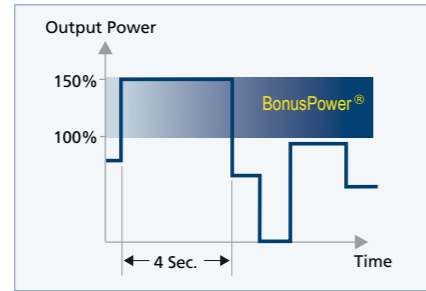

BonusPower®:  
150% Output power available up to 4 seconds for dynamic loads.

#### DIMENSION C-Series

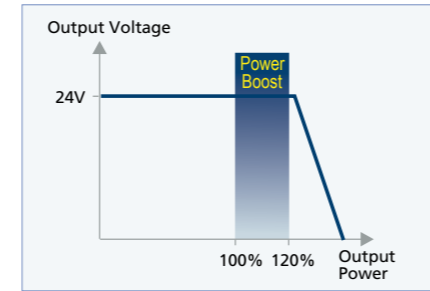

Power Boost:  
20% Extra output current for dynamic loads, continuous operation is available up to +45°C.

#### DIMENSION Q-Series



The DC-OK relay contact monitors the actual output voltage generated from the power supply. Perfect for redundant use.

1-Phase Power Supplies Output: 24V	72-82W			91-100W			120W					
	3.0A	3.3A	3.4A	3.8A	3.95A	4.2A	5A	5A	5A	5A	5A	5A
Family	MiniLine	DIMENSION-C	DIMENSION-Q	DIMENSION-Q	MiniLine	MiniLine	DIMENSION-C	DIMENSION-C	DIMENSION-C	DIMENSION-Q	SilverLine	SilverLine
Output Voltage	nom. 24-28V	24-28V	24-28V	24-28V	24-28V	24-28V	24-28V	24-28V	24-28V	24-28V	24V	24V
Output Current	continuous	nom. 3-2.6A	3.3-2.7A	3.4-3A	3.8A	3.95-3.4A	4.2-3.6A	5-4.3A	5-4.3A	5-4.3A	5-4.5A	5A
Output Current	short-term	–	–	5-4.5A <sup>K)</sup>	(5.7A after turn-on)	–	–	6-5.1A <sup>L)B)</sup>	6-5.1A <sup>L)B)</sup>	6-5.1A <sup>L)</sup>	7.5-6.7A <sup>K)</sup>	6A <sup>G)</sup>
Output Power	continuous	nom. 72W	80W	82W	91.2W	95W	100W	120W	120W	120W	120W	120W
Output Power	short-term	–	–	120W <sup>K)</sup>	–	–	–	144W <sup>L)B)</sup>	144W <sup>L)B)</sup>	144W <sup>L)</sup>	180W <sup>K)</sup>	144W <sup>G)</sup>
Power Reserves	min.	–	–	+50% BonusPower <sup>®K)</sup>	–	–	–	+20% Power Boost <sup>L)B)</sup>	+20% Power Boost <sup>L)B)</sup>	+20% Power Boost <sup>L)</sup>	+50% BonusPower <sup>®K)</sup>	+20% Power Boost <sup>G)</sup>
Factory Setting <sup>1)</sup>	typ.	24.5V	24.1V	24.1V	24.1V	24.5V	24.5V	24.1V	24.1V	24.1V	24.1V	24.5V
Ripple & Noise Voltage <sup>2)</sup>	max.	50mVpp	50mVpp	50mVpp	50mVpp	50mVpp	50mVpp	50mVpp	50mVpp	50mVpp	50mVpp	30mVpp
Overload Behaviour		continuous current	continuous current	continuous current	continuous current	continuous current	cont. current	continuous current	continuous current	continuous current	continuous current	continuous current
AC Input Voltage	nom.	AC 100-120V/ 200-240V <sup>#)</sup>	AC 100-240V ±10%	AC 100-240V ±15%	AC 100-240V -15% / +10%	AC 100-120V/ 200-240V <sup>◇)</sup>	AC 100-120V/ 200-240V <sup>◇)</sup>	AC 100-120V/ 200-240V <sup>◇)</sup>	AC 100-120V/ 200-240V <sup>◇)</sup>	AC 200-240V ±10%	AC 100-240V -15% / +10%	AC 100-120V/ 200-240V <sup>#)</sup>
Input Current <sup>3)</sup>	max.	1.6/0.8A	1.6A	1.8A	1.1A	2.0/0.95A	2.1/1.0A	2.6/1.4A	2.6A	1.4A	1.4A	2.6/1.4A
Harmonic Correction <sup>8)</sup>		–	–	yes	active	–	–	–	–	–	active	–
EN 61000-3-2 (PFC Norm)		fulfilled	fulfilled	fulfilled	fulfilled	fulfilled	fulfilled	not fulfilled	not fulfilled	fulfilled	fulfilled	fulfilled
Power Factor 120/230Vac <sup>1)</sup>	typ.	0.63/0.54	0.61/0.56	0.53/0.47	0.98/0.9	0.62/0.55	0.62/0.55	0.56/0.47	0.59/–	–/0.5	0.99/0.91	0.56/0.49
Hold-Up Time 120/230Vac <sup>1)</sup>	typ.	47/48ms	30/128ms	41/174ms	44/85ms	41/46ms	38/44ms	80/78ms	80ms/–	–/78ms	34/65ms	57/58ms
Input Inrush Current Limiter		NTC	NTC	active	active	NTC	NTC	active	NTC	NTC	active	NTC
Input Inrush Current 120Vac <sup>5)</sup>	typ.	26A; 1.1A <sup>2s</sup>	23A; 0.5A <sup>2s</sup>	5A; 2A <sup>2s</sup>	9A; 0.5A <sup>2s</sup>	22A; 0.4A <sup>2s</sup>	22A; 0.4A <sup>2s</sup>	3A; 1A <sup>2s</sup>	45A; 3A <sup>2s</sup>	–	9A; 0.5A <sup>2s</sup>	16A; 1.6A <sup>2s</sup>
Input Inrush Current 230Vac <sup>5)</sup>	typ.	30A; 0.9A <sup>2s</sup>	45A; 1.7A <sup>2s</sup>	10A; 2A <sup>2s</sup>	11A; 0.5A <sup>2s</sup>	37A; 1.4A <sup>2s</sup>	37A; 1.4A <sup>2s</sup>	3A; 1A <sup>2s</sup>	–	30A; 1A <sup>2s</sup>	11A; 0.5A <sup>2s</sup>	18A; 1.1A <sup>2s</sup>
External Input Circuit Breaker <sup>4)</sup>	min.	B-10A; C-6A	B-10A; C-6A	B-6A; C-6A	B-6A; C-3A	B-10A; C-6A	B-10A; C-6A	B-10A; C-6A	B-16A; C-10A	B-16A; C-10A	B-6A; C-3A	B-10A; C-6A
DC Input Voltage	nom.	DC 260-300V <sup>5)T)</sup>	DC 110-300V <sup>T)</sup>	DC 110-300V <sup>T)</sup>	DC 110-300V <sup>T)</sup>	DC 260-300V <sup>5)T)</sup>	DC 260-300V <sup>5)T)</sup>	–	–	DC 250-300V <sup>5)T)</sup>	DC 110-300V <sup>T)</sup>	DC 250-300V <sup>5)T)</sup>
Efficiency 120/230Vac <sup>1)</sup>	typ.	90.6/91.5%	88.0/89.8%	88.7/90.0%	91.4/92.0%	88.5/90.0%	88.5/90.0%	89.4/90.2%	90.0%/–	–/90.2%	91.6/92.7%	88.7/89.3%
Power Losses 120/230Vac <sup>1)</sup>	typ.	7.5/6.7W	11.1/9.1W	10.4/9.1W	8.6/7.9W	11.6/9.9W	13.0/11.1W	14.5/13.2W	13.5W/–	–/13.2W	11.0/9.4W	15.3/14.4W
MTBF <sup>6)</sup>	typ.	2038 kh	2243 kh	1451 kh	831 kh	1551 kh	1551 kh	869 kh	740 kh	940 kh	831 kh	2109 kh
Operational Temperature Range	min.	-10°C to +70°C	-25°C to +70°C	-25°C to +70°C	-25°C to +70°C	-10°C to +70°C	-10°C to +70°C	-25°C to +70°C	-10°C to +70°C	-10°C to +70°C	-25°C to +70°C	-10°C to +70°C
Derating +60°C to +70°C	min.	1.8W/°C	1.8W/°C	2W/°C	2W/°C	2W/°C	2.5W/°C	3W/°C	3W/°C	3W/°C	3W/°C	3W/°C
Dimensions WxHxD <sup>7)</sup>	nom.	45x75x91mm	32x124x102mm	32x124x102mm	40x124x117mm	72.5x75x103mm	72.5x75x103mm	32x124x117mm	32x124x117mm	32x124x117mm	40x124x117mm	64x124x102mm
Connection Terminals		spring terminals	screw terminals	spring terminals	spring terminals	spring terminals	spring terminals	screw terminals	screw terminals	screw terminals	spring terminals	screw terminals
Weight	max.	260g	430g	440g	620g	360g	360g	500g	500g	500g	620g	620g
DC-OK-Signal		no	no	no	yes <sup>P)</sup>	no	no	no	no	no	yes <sup>P)</sup>	no
Parallel Use		yes <sup>M)</sup>	no <sup>J)</sup>	yes	no	no	yes <sup>N)</sup>	no <sup>J)</sup>	no <sup>J)</sup>	no <sup>J)</sup>	yes <sup>M)</sup>	yes
Series Connection <sup>9)</sup>		yes	yes	yes	no	no	yes	yes	yes	yes	yes	yes
Bracket for Wall/Panel Mounting		included	ZM1.WALL	ZM1.WALL	ZM1.WALL	–	–	ZM1.WALL	ZM1.WALL	ZM1.WALL	ZM1.WALL	SLZ02
Bracket for Side Mounting		–	ZM11.SIDE	ZM11.SIDE	ZM12.SIDE	–	–	ZM11.SIDE	ZM11.SIDE	ZM11.SIDE	ZM12.SIDE	–
Special Features					NEC-Class-2 DeviceNet <sup>®)</sup>	NEC-Class-2				120V Version	230V Version	redundant unit with decoupling diode
Order Number		ML70.100	CS3.241	QS3.241	QS5.DNET	ML95.100	ML100.100 ML100.109*)	CS5.241 CS5.241-C1*) CS5.241-S1*)	CS5.243	CS5.244	QS5.241	SL5.100 SLR5.100

\*) ML100.109 and CS5.241-C1 with conformal coated PC-board, CS5.241-S1 with spring-clamp terminals, #) Manual-select by slide-switch, ◇) Auto-select input  
Fold out the back page to find the appropriate footnotes.  
Information regarding standards and approvals can be found on pages 42 to 44.  
Visit [www.pulspower.com](http://www.pulspower.com) for detailed datasheets.



#### DIMENSION Q-Series

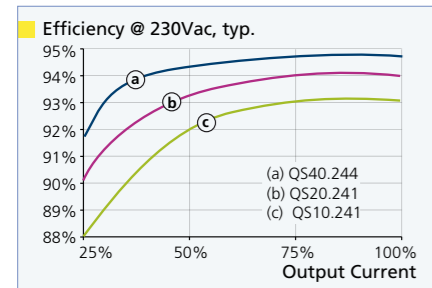

The premium class efficiency means that significantly less heat is produced. The service life of all components in the cabinet is extended.

#### DIMENSION, SilverLine, MiniLine

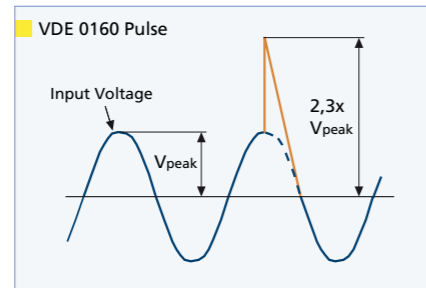

All power supplies are protected against high energy input transients.

#### DIMENSION Q-Series

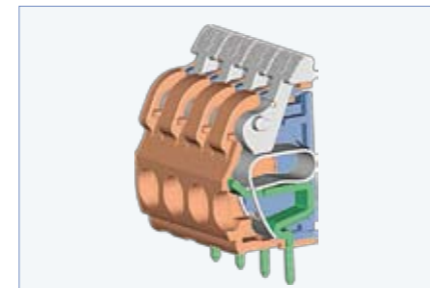

For a secure connection: Vibration proof quick-connect spring-clamp terminals. No tools required.

#### DIMENSION, SilverLine, MiniLine

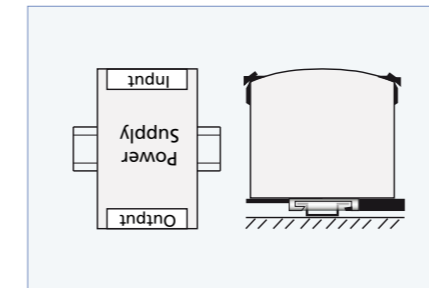

Need different mounting orientations? The maximum allowed output current for safe operation can be found in the datasheet.

1-Phase Power Supplies Output: 24V	196W			240W			240W			480W		960W
	8A			10A			10A			20A		40A
Family	DIMENSION-Q			DIMENSION-C			DIMENSION-C			DIMENSION-Q		DIMENSION-Q
Output Voltage	nom. 24-24.5V			nom. 24-28V			nom. 24-28V			nom. 24-28V		nom. 24-28V
Output Current	nom. 8A			nom. 10-8.6A			nom. 10-8.6A			nom. 20-17A		nom. 40-34.3A
Output Current	short-term (12A after turn-on)			short-term 12-10.3A <sup>L</sup>			short-term 12-10.3A <sup>L</sup>			short-term 30-26A <sup>K</sup>		short-term 60-51.5A <sup>K</sup>
Output Power	continuous nom. 196W			continuous nom. 240W			continuous nom. 240W			continuous nom. 480W		continuous nom. 960W
Output Power	short-term -			short-term 288W <sup>L</sup>			short-term 288W <sup>L</sup>			short-term 720W <sup>K</sup>		short-term 1440W <sup>K</sup>
Power Reserves	min. -			min. +20% Power Boost <sup>L</sup>			min. +20% Power Boost <sup>L</sup>			min. +20% Power Boost <sup>G</sup>		min. +50% BonusPower <sup>K</sup>
Factory Setting <sup>1)</sup>	typ. 24.1V			typ. 24.1V			typ. 24.1V			typ. 24.1V		typ. 24.1V
Ripple & Noise Voltage <sup>2)</sup>	max. 50mVpp			max. 50mVpp			max. 50mVpp			max. 100mVpp		max. 100mVpp
Overload Behaviour	continuous current			continuous current			continuous current			Hiccup-mode		Hiccup-mode
AC Input Voltage	nom. AC 100-240V ±15%			nom. AC 100-120V/200-240V <sup>O</sup> ±10%			nom. AC 100-120V/200-240V <sup>O</sup> ±10%			nom. AC 100-240V ±15%		nom. AC 200-240V ±15%
Input Current <sup>3)</sup>	max. 2.3A			max. 5.0/2.7A			max. 5.0A			max. 5.4A		max. 5.4A
Harmonic Correction <sup>8)</sup>	active			PFC inductor			active			active		active
EN 61000-3-2 (PFC Norm)	fulfilled			not fulfilled			fulfilled			fulfilled		fulfilled
Power Factor 120/230Vac <sup>1)</sup>	typ. 0.98/0.92			typ. 0.59/0.51			typ. 0.57/-			typ. 0.98/0.92		typ. 0.95/0.9
Hold-Up Time 120/230Vac <sup>1)</sup>	typ. 33/34ms			typ. 46/47ms			typ. 46/42ms			typ. 27/28ms		typ. 61/60ms
Input Inrush Current Limiter	active			active			NTC			active		passiv <sup>R)</sup>
Input Inrush Current 120Vac <sup>5)</sup>	typ. 4A; 0.6A <sup>2</sup> s			typ. 3A; 1A <sup>2</sup> s			typ. 3A; 1A <sup>2</sup> s			typ. 85A; 8.5A <sup>2</sup> s		typ. 4A; 0.6A <sup>2</sup> s
Input Inrush Current 230Vac <sup>5)</sup>	typ. 7A; 0.6A <sup>2</sup> s			typ. 3A; 1A <sup>2</sup> s			typ. 3A; 1A <sup>2</sup> s			typ. 48A; 3A <sup>2</sup> s		typ. 7A; 0.6A <sup>2</sup> s
External Input Circuit Breaker <sup>4)</sup>	min. B-6A; C-4A			min. B-10A; C-6A			min. B-10A; C-6A			min. B-16A; C-10A		min. B-6A; C-4A
DC Input Voltage	nom. DC 110-300V <sup>T)</sup> -20%/+25%			nom. -			nom. -			nom. DC 250-300V <sup>S) T) U)</sup> -15%/+25%		nom. DC 110-300V <sup>T)</sup> -20%/+25%
Efficiency 120/230Vac <sup>1)</sup>	typ. 92.3/92.7%			typ. 91.0/91.6%			typ. 91.0/91.2%			typ. 91.3%/		typ. -/91.3%
Power Losses 120/230Vac <sup>1)</sup>	typ. 16.0/15.1W			typ. 23.7/22.0W			typ. 23.7/23.2W			typ. 23.4W/		typ. -/23.4W
MTBF <sup>6)</sup>	typ. 621 kh			typ. 821 kh			typ. 810 kh			typ. 710 kh		typ. 910 kh
Operational Temperature Range	min. -25°C to +70°C			min. -25°C to +70°C			min. -25°C to +70°C			min. 0°C to +70°C		min. 0°C to +70°C
Derating +60°C to +70°C	min. 5W/°C			min. 6W/°C			min. 6W/°C			min. 6W/°C		min. 6W/°C
Dimensions WxHxD <sup>7)</sup>	nom. 60x124x117mm			nom. 60x124x117mm			nom. 60x124x117mm			nom. 60x124x117mm		nom. 120x124x102mm
Connection Terminals	spring terminals			screw terminals			screw terminals			spring terminals		plug connectors
Weight	max. 900g			max. 700g			max. 800g			max. 700g		max. 900g
DC-OK-Signal	yes <sup>P)</sup>			no			no			yes <sup>P)</sup>		yes <sup>P)</sup>
Parallel Use	yes			no <sup>J)</sup>			no <sup>J)</sup>			yes		yes <sup>N)</sup>
Series Connection <sup>9)</sup>	no			yes			yes			no		no
Bracket for Wall/Panel Mounting	ZM1.WALL			ZM1.WALL			ZM1.WALL			ZM1.WALL		ZM1.WALL
Bracket for Side Mounting	ZM13.SIDE			ZM13.SIDE			ZM13.SIDE			ZM13.SIDE		ZM13.SIDE
Special Features	DeviceNet <sup>®</sup> approved			with PFC inductor			120V Version			230V Version		redundant unit with decoupling diode
Order Number	QS10.DNET			CS10.241 CS10.241-S1*)			CS10.242			CS10.243		CS10.244
												QS10.241 QS10.241-C1*)
												SL10.100
												SLR10.100
												redundant unit with decoupling diode
												QS20.241 QS20.241-C1*)
												QS20.244
												QS40.244

\*) QS10.241-C1, QS20.241-C1 with conformal coated PC-board, CS10.241-S1 with spring-clamp terminals, #) Manual-select by slide-switch, O) Auto-select input

Fold out the back page to find the appropriate footnotes.

Information regarding standards and approvals can be found on pages 42 to 44.

Visit [www.pulspower.com](http://www.pulspower.com) for detailed datasheets.

# 1-Phase Power Supplies with Output Voltages other than 24V

## Versatile applications:

Apart from standard 24V units of the MiniLine and DIMENSION family, other output voltages are also available. Typical applications include the supply of motors, drive systems, laser diodes, radio modems, building access control systems, ticket printers or simply the charging of batteries. Typical areas of application for these units are in facility control, the chemical industry, measurement equipment as well as in many other areas.

1-Phase Power Supplies Output: 5-15V			5V		10-12V	12-15V		12-15V	±12-15V	
			3A	5A	2.5A	1.3A	4.2A	7.5A	15A	1.5A
Family			MiniLine	MiniLine	MiniLine	MiniLine	MiniLine	MiniLine	DIMENSION-Q	MiniLine
Output Voltage			5-5.5V	5-5.5V	10-12V	12-15V	12-15V	12-15V	12-15V	±12-15V
Output Current	continuous	nom.	3A	5A	3-2.5A	1.3-1A	4.2-3.3A	7.5-6A	15-13.5A	2x1.5A
Output Current	short-term		-	-	-	-	-	-	22.5-20.3A <sup>K)</sup>	-
Output Power	continuous	nom.	15W	25W	30W	15W	50W	90W	180W	36W
Output Power	short-term		-	-	-	-	-	-	270W <sup>K)</sup>	-
Power Reserves		min.	-	-	-	-	-	-	+50% BonusPower <sup>®K)</sup>	-
Factory Setting <sup>1)</sup>		typ.	5.1V	5.1V	12.0V <sup>#)</sup>	12.0V	15.0V <sup>#)</sup>	12.0V	12.0V	±15.0V <sup>#)</sup>
Ripple & Noise Voltage <sup>2)</sup>		max.	50mVpp	50mVpp	10mVpp	75mVpp	50mVpp	50mVpp	50mVpp	50mVpp
Overload Behaviour			Hiccup-mode	continuous current	continuous current	Hiccup-mode	continuous current	conti. current	continuous current	continuous current
AC Input Voltage		nom.	AC 100-240V -15%/+10%	AC 100-240V -15%/+10%	AC 100-240V -15%/+10%	AC 100-240V -15%/+10%	AC 100-240V -15%/+10%	AC 100-120V/ 200-240V <sup>⊃)</sup> -15%/+10%	AC 100-240V ±15%	AC 100-240V -15%/+10%
Input Current <sup>3)</sup>		max.	0.3A	0.5A	0.6A	0.3A	1.0A	1.9/0.9A	2.2A	0.7A
Harmonic Correction <sup>8)</sup>			-	-	-	-	-	-	active	-
EN 61000-3-2 (PFC Norm)			no	no	no	no	no	fulfilled	fulfilled	no
Power Factor 120/230Vac <sup>1)</sup>		typ.	0.51/0.44	0.61/0.53	0.61/0.53	0.51/0.44	0.56/0.52	0.62/0.55	0.98/0.92	0.61/0.53
Hold-Up Time 120/230Vac <sup>1)</sup>		typ.	45/186ms	52/230ms	46/200ms	46/191ms	40/180ms	41/46ms	32/32ms	54/236ms
Input Inrush Current Limiter			NTC	NTC	NTC	NTC	NTC	NTC	active	NTC
Input Inrush Current 120Vac <sup>5)</sup>		typ.	13A; 0.1A <sup>2s</sup>	17A; 0.3A <sup>2s</sup>	17A; 0.3A <sup>2s</sup>	13A; 0.1A <sup>2s</sup>	17A; 0.4A <sup>2s</sup>	22A; 0.4A <sup>2s</sup>	4A; 0.6A <sup>2s</sup>	17A; 0.4A <sup>2s</sup>
Input Inrush Current 230Vac <sup>5)</sup>		typ.	26A; 0.4A <sup>2s</sup>	35A; 1.1A <sup>2s</sup>	35A; 1.1A <sup>2s</sup>	26A; 0.4A <sup>2s</sup>	35A; 1.5A <sup>2s</sup>	37A; 1.4A <sup>2s</sup>	7A; 0.6A <sup>2s</sup>	35A; 1.5A <sup>2s</sup>
External Input Circuit Breaker <sup>4)</sup>		min.	B-6A; C-3A	B-10A; C-6A	B-10A; C-6A	B-6A; C-3A	B-10A; C-6A	B-10A; C-6A	B-6A; C-4A	B-10A; C-6A
DC Input Voltage		nom.	DC 110-300V <sup>⊃)</sup> -20%/+25%	DC 110-300V <sup>⊃)</sup> -20%/+25%	DC 110-300V <sup>⊃)</sup> -20%/+25%	DC 110-300V <sup>⊃)</sup> -20%/+25%	DC 110-300V <sup>⊃)</sup> -20%/+25%	DC 260-300V <sup>⊃)</sup> -15%/+25%	DC 110-300V <sup>⊃)</sup> -20%/+25%	DC 110-300V <sup>⊃)</sup> -20%/+25%
Efficiency 120/230Vac <sup>1)</sup>		typ.	76.8/77.2%	79.0/80.0%	82.6/84.0%	83.0/82.5%	87.5/90.0%	87.7/88.5%	91.5/91.8%	84.0/86.0%
Power Losses 120/230Vac <sup>1)</sup>		typ.	4.6/4.5W	6.6/6.3W	6.3/5.7W	3.2/3.2W	7.1/5.6W	12.6/11.7W	16.7/16.1W	6.9/5.9W
MTBF <sup>6)</sup>		typ.	2686 kh	1963 kh	2507 kh	3811 kh	2365 kh	1310 kh	631 kh	3010 kh
Operational Temperature Range		min.	-10°C to +70°C	-10°C to +70°C	-10°C to +70°C	-10°C to +70°C	-10°C to +70°C	-10°C to +70°C	-25°C to +70°C	-10°C to +70°C
Derating +60°C to +70°C		min.	0.4W/°C	0.8W/°C	0.8W/°C	0.4W/°C	1.3W/°C	2.5W/°C	6W/°C	1W/°C
Dimensions WxHxD <sup>7)</sup>		nom.	22.5x75x91mm	45x75x91mm	45x75x91mm	22.5x75x91mm	45x75x91mm	72.5x75x103mm	60x124x117mm	45x75x91mm
Connection Terminals			screw terminals	spring terminals	spring terminals	screw terminals	spring terminals	spring terminals	spring terminals	spring terminals
Weight		max.	130g	240g	250g	130g	260g	360g	930g	240g
DC-OK-Signal			no	no	no	no	no	no	yes <sup>P)</sup>	no
Parallel Use			yes <sup>M)</sup>	yes <sup>M)</sup>	yes <sup>M)</sup>	yes <sup>M)</sup>	yes <sup>M)</sup>	yes <sup>N)</sup>	yes	no
Series Connection <sup>9)</sup>			yes	yes	yes	yes	no	no	yes	no
Bracket for Wall/Panel Mounting			-	included	included	-	included	-	ZM1.WALL	included
Bracket for Side Mounting			-	-	-	-	-	-	ZM13.SIDE	-
Special Features					very low ripple&noise					dual output with common ground
Order Number			<b>ML15.051</b>	<b>ML30.101</b>	<b>ML30.102</b>	<b>ML15.121</b>	<b>ML50.102</b>	<b>ML100.102</b>	<b>QS10.121</b>	<b>ML30.106</b>

⊃) Auto-select input, #) A missing or detached jumper adjusts the units to 10V (ML30.102), ±12V (ML30.106) or 12V (ML50.102)

Fold out the back page to find the appropriate footnotes.

Information regarding standards and approvals can be found on pages 42 to 44.

Visit [www.pulspower.com](http://www.pulspower.com) for detailed datasheets.



ML30.102 12V  
ML30.106 ±15V  
ML50.102 15V

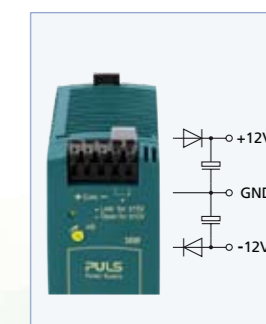

ML30.106  
Two output voltages in one device.

Easy adjustment of the output voltage with the help of a jumper.

### Parallel and series connection of power supplies:

In case you cannot find what you need among the listed products, many units can be connected in series or in parallel. A series connection is allowed up to a total output voltage of 150Vdc on most of the power supplies. If higher output currents are needed, power supplies can be connected in parallel. More information can be found in the chapter "Technical Notes" on pages 50 and 51.

1-Phase Power Supplies			30V	36V	48V			48V
Output: 30-56V			8A	13.3A	1.05A	2.1A	5A	10A
Family			DIMENSION-Q	DIMENSION-Q	MiniLine	MiniLine	DIMENSION-C	DIMENSION-Q
Output Voltage	nom.		28-32V	36-42V	48-56V	48-56V	48-52V	48-56V
Output Current	continuous	nom.	8.6-7.5A	13.3-11.4A	1.05-0.9A	2.1-1.8A	5-4.6A	10-8.7A
Output Current	short-term		12.8-11.3A <sup>K)</sup>	20-17.1A <sup>K)</sup>	-	-	6-5.5A <sup>L)</sup>	15-13A <sup>K)</sup>
Output Power	continuous	nom.	240W	480W	50W	100W	240W	480W
Output Power	short-term		360W <sup>K)</sup>	720W <sup>K)</sup>	-	-	288W <sup>L)</sup>	720W <sup>K)</sup>
Power Reserves	min.		+50% BonusPower <sup>®</sup> <sup>K)</sup>	+50% BonusPower <sup>®</sup> <sup>K)</sup>	-	-	+20% Power Boost <sup>L)</sup>	+50% BonusPower <sup>®</sup> <sup>K)</sup>
Factory Setting <sup>1)</sup>	typ.		30.0V	36.0V	48.0V	48.0V	48.0V	48.0V
Ripple & Noise Voltage <sup>2)</sup>	max.		50mVpp	100mVpp	50mVpp	50mVpp	100mVpp	100mVpp
Overload Behaviour			continuous current	Hiccup-mode	continuous current	continuous current	continuous current	Hiccup-mode
AC Input Voltage	nom.		AC 100-240V ±15%	AC 100-240V ±15%	AC 100-240V -15% / +10%	AC 100-120V/ 200-240V <sup>O)</sup> -15%/+10%	AC 100-120V/ 200-240V <sup>O)</sup> ±10%	AC 100-240V ±15%
Input Current <sup>3)</sup>	max.		2.8A	5.4A	1.0A	2.1/1.0A	5.0/2.7A	2.8A
Harmonic Correction <sup>8)</sup>			active	active	-	-	-	active
EN 61000-3-2 (PFC Norm)			fulfilled	fulfilled	no	fulfilled	not fulfilled	fulfilled
Power Factor 120/230Vac <sup>1)</sup>	typ.		0.98/0.92	0.95/0.9	0.56/0.52	0.62/0.55	0.59/0.51	0.98/0.92
Hold-Up Time 120/230Vac <sup>1)</sup>	typ.		22/23ms	32/51ms	40/180ms	38/44ms	46/47ms	27/28ms
Input Inrush Current Limiter			active	active	NTC	NTC	active	active
Input Inrush Current 120Vac <sup>5)</sup>	typ.		4A; 0.6A <sup>2</sup> s	9A; 5A <sup>2</sup> s	17A; 0.4A <sup>2</sup> s	22A; 0.4A <sup>2</sup> s	3A; 1A <sup>2</sup> s	4A; 0.6A <sup>2</sup> s
Input Inrush Current 230Vac <sup>5)</sup>	typ.		7A; 0.6A <sup>2</sup> s	7A; 5A <sup>2</sup> s	35A; 1.5A <sup>2</sup> s	37A; 1.4A <sup>2</sup> s	3A; 1A <sup>2</sup> s	7A; 5A <sup>2</sup> s
External Input Circuit Breaker <sup>4)</sup>	min.		B-6A; C-4A	B-10A; C-6A	B-10A; C-6A	B-10A; C-6A	B-6A; C-4A	B-10A; C-6A
DC Input Voltage	nom.		DC 110-300V <sup>T)</sup> -20%/+25%	DC 110-300V <sup>T)</sup> -20%/+25%	DC 110-300V <sup>S)</sup> <sup>T)</sup> -20%/+25%	DC 260-300V <sup>S)</sup> <sup>T)</sup> -15%/+25%	-	DC 110-300V <sup>T)</sup> -20%/+25%
Efficiency 120/230Vac <sup>1)</sup>	typ.		92.3/93.0%	92.5/94.0%	88.9/90.3%	90.4/91.8%	91.0/91.6%	91.2/92.0%
Power Losses 120/230Vac <sup>1)</sup>	typ.		20.0/18.1W	38.9/30.6W	6.2/5.4W	10.6/8.9W	23.7/22.0W	37.2/29.0W
MTBF <sup>6)</sup>	typ.		571 kh	469 kh	1970 kh	1671 kh	835 kh	606 kh
Operational Temperature Range	min.		-25°C to +70°C	-25°C to +70°C	-10°C to +70°C	-10°C to +70°C	-25°C to +70°C	-25°C to +70°C
Derating +60°C to +70°C	min.		6W/°C	12W/°C	1.3W/°C	2.5W/°C	6W/°C	6W/°C
Dimensions WxHxD <sup>7)</sup>	nom.		60x124x117mm	82x124x127mm	45x75x91mm	72.5x75x103mm	60x124x117mm	60x124x117mm
Connection Terminals			spring terminals	spring terminals	spring terminals	spring terminals	screw terminals	spring terminals
Weight	max.		900g	1200g	240g	360g	700g	900g
DC-OK-Signal			yes <sup>P)</sup>	yes <sup>P)</sup>	no	no	no	yes <sup>P)</sup>
Parallel Use			yes	yes	yes	yes <sup>N)</sup>	no <sup>J)</sup>	yes
Series Connection <sup>9)</sup>			yes	yes	yes	yes	yes	yes
Bracket for Wall/Panel Mounting			ZM1.WALL	ZM1.WALL	included	-	ZM1.WALL	ZM1.WALL
Bracket for Side Mounting			ZM13.SIDE	ZM15.SIDE	-	-	ZM13.SIDE	ZM15.SIDE
Special Features								
<b>Order Number</b>			<b>QS10.301</b>	<b>QS20.361</b>	<b>ML50.105</b>	<b>ML100.105</b>	<b>CS10.481</b>	<b>QS10.481</b>
							<b>QS10.481</b>	<b>QS20.481</b>

⌘) Auto-select input  
 Fold out the back page to find the appropriate footnotes.  
 Information regarding standards and approvals can be found on pages 42 to 44.  
 Visit [www.pulspower.com](http://www.pulspower.com) for detailed datasheets.





## 24V Power Supplies for 3-Phase Systems

### Designed for the harsh industrial environment:

Industrial three-phase systems present a special challenge when designing power supplies. High energy transients and superimposed disturbances on the input lines require special input filters and protection circuits. PULS units are equipped with special active and passive filters.



3-Phase Power Supplies Output: 24V	90-100W		120W	
	3.75A	4.2A	5A	5A
Family	MiniLine	MiniLine	DIMENSION-C	SilverLine
Output Voltage	nom. 24-28V	24-28V	24-28V	24-28V
Output Current continuous	nom. 3.75-3.2A	4.2-3.6A	5-4.3A	5-4.3A
Output Current short-term	-	-	6-5.2A <sup>L)</sup>	6-5.2A <sup>G)</sup>
Output Power continuous	nom. 90W	100W	120W	120W
Output Power short-term	-	-	144W <sup>L)</sup>	144W <sup>G)</sup>
Power Reserves	min. -	-	+20% Power Boost <sup>L)</sup>	+20% Power Boost <sup>G)</sup>
Factory Setting <sup>1)</sup>	typ. 24.5V	24.5V	24.1V	24.5V
Ripple & Noise Voltage <sup>2)</sup>	max. 50mVpp	50mVpp	50mVpp	25mVpp
Overload Behaviour	continuous current	continuous current	continuous current	continuous current
AC Input Voltage	nom. 2AC 380-480V ±15%	2AC 380-480V ±15%	2AC 380-480V -15%/+20%	3AC 400-500V ±15%
2-Phase-Operation	100% <sup>A)</sup>	100% <sup>A)</sup>	100% <sup>A)</sup>	100% <sup>A)</sup>
Input Current <sup>3)</sup>	max. 0.5A	0.6A	0.75A	0.4A
Harmonic Correction <sup>8)</sup>	-	-	PFC inductor	PFC inductor
EN 61000-3-2 (PFC Norm)	fulfilled	fulfilled	fulfilled	fulfilled
Power Factor 400/480Vac <sup>1)</sup>	typ. 0.60/0.55	0.60/0.55	0.45/0.43	0.52/0.49
Hold-Up Time 400/480Vac <sup>1)</sup>	typ. 52/93ms	48/85ms	27/48ms	30/45ms
Input Inrush Current Limiter	NTC	NTC	active	NTC
Input Inrush Current 400Vac <sup>5)</sup>	typ. 30A; 0.7A <sup>2</sup> s	30A; 0.7A <sup>2</sup> s	4A; 0.5A <sup>2</sup> s	16A; 1.1A <sup>2</sup> s
Input Inrush Current 480Vac <sup>5)</sup>	typ. 36A; 1A <sup>2</sup> s	36A; 1A <sup>2</sup> s	4A; 0.5A <sup>2</sup> s	19A; 1.3A <sup>2</sup> s
External Input Circuit Breaker <sup>4)</sup>	min. B-10A; C-6A	B-10A; C-6A	B-6A; C-4A	B-10A; C-6A
DC Input Voltage	nom. DC 600V <sup>5) T) U)</sup> -25%/+35%	DC 600V <sup>5) T) U)</sup> -25%/+35%	DC 600V <sup>5) T) U)</sup> -25%/+30%	DC 600V <sup>5) T) U)</sup> -25%/+35%
Efficiency 400/480Vac <sup>1)</sup>	typ. 89.5/89.0%	89.5/89.0%	90.4/90.0%	88.8/88.9%
Power Losses 400/480Vac <sup>1)</sup>	typ. 10.5/11.1W	11.7/12.3W	12.7/13.3W	15.1/15.0W
MTBF <sup>6)</sup>	typ. 1594 kh	1594 kh	1173 kh	1798 kh
Operational Temperature Range	min. -10°C to +70°C	-10°C to +70°C	-25°C to +70°C	-10°C to +70°C
Derating +60°C to +70°C	min. 2W/°C	2.5W/°C	3W/°C	3W/°C
Dimensions WxHxD <sup>7)</sup>	nom. 72.5x75x103mm	72.5x75x103mm	40x124x117mm	73x124x117mm
Connection Terminals	spring terminals	spring terminals	screw terminals	screw terminals
Weight	max. 360g	360g	500g	730g
DC-OK-Signal	no	no	no	no
Parallel Use	no	yes <sup>M)</sup>	yes <sup>M)</sup>	yes <sup>M)</sup>
Serial Use <sup>9)</sup>	no	yes	yes	no
Bracket for Wall/Panel Mounting	-	-	ZM1.WALL	SLZ02
Bracket for Side Mounting	-	-	ZM12.SIDE	-
Special Features	1-Ph 400/480V input. NEC-Class-2	1-Ph 400/480V input	1-Ph 400/480V input	-
<b>Order Number</b>	<b>ML90.200</b>	<b>ML100.200</b>	<b>CT5.241</b>	<b>SL5.300</b>

Fold out the back page to find the appropriate footnotes.  
Information regarding standards and approvals can be found on pages 42 to 44.  
Visit [www.pulspower.com](http://www.pulspower.com) for detailed datasheets.



#### Highest efficiencies care for the environment and save money at the same time

There is no doubt that the best contribution we can make to actively protecting the environment and climate is to avoid unnecessary energy consumption and to use resources responsibly. Advanced technologies employed by PULS in the design of power supply units allow the construction of highly efficient devices with reduced levels of loss and wasted heat. PULS consistently utilises, develops and evolves these technologies and passes the benefits onto its customers. The environment is protected while the reduced energy and system costs often allow substantial financial savings.

Please refer to our "Saving Energy" brochure for facts and figures.

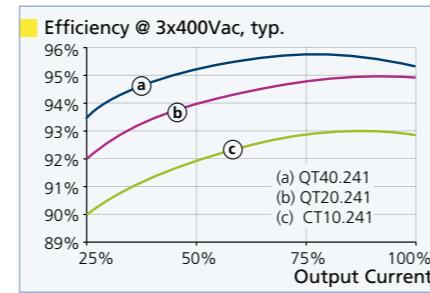

3-Phase Power Supplies Output: 24V	240W		480W		960W			
	10A	10A	20A	20A	40A	40A	40A	40A
Family	DIMENSION-C	SilverLine	DIMENSION-Q	SilverLine	DIMENSION-Q	SilverLine	DIMENSION-X	DIMENSION-X
Output Voltage	nom. 24-28V	24-28V	24-28V	24-28V	24-28V	24-28V	24V ±2% †)	24V ±2% †)
Output Current	continuous nom. 10-8.6A	10-8.6A	20-17.5A	20-17.1A	40-34.3A	40-34.3A	40A	40A
Output Current	short-term 12-10.3A <sup>L)</sup>	12-10.3A <sup>G)</sup>	30-26A <sup>K)</sup>	25-21.5A <sup>G)</sup>	60-51.5A <sup>K)</sup>	45-38.6A <sup>G)</sup>	50A <sup>H)</sup>	50A <sup>H)</sup>
Output Power	continuous nom. 240W	240W	480W	480W	960W	960W	960W	960W
Output Power	short-term 288W <sup>L)</sup>	288W <sup>G)</sup>	720W <sup>K)</sup>	600W <sup>G)</sup>	1440W <sup>K)</sup>	1080W <sup>G)</sup>	1200W <sup>H)</sup>	1200W <sup>H)</sup>
Power Reserves	min. +20% Power Boost <sup>L)</sup>	+20% Power Boost <sup>G)</sup>	+50% BonusPower® <sup>K)</sup>	+25% Power Boost <sup>G)</sup>	+50% BonusPower® <sup>K)</sup>	+12.5% Power Boost <sup>G)</sup>	+25% BonusPower® <sup>H)</sup>	+25% BonusPower® <sup>H)</sup>
Factory Setting <sup>1)</sup>	typ. 24.1V	24.5V	24.1V	24.5V	24.1V	24.0V	24.1V	24.1V
Ripple & Noise Voltage <sup>2)</sup>	max. 50mVpp	30mVpp	100mVpp	30mVpp	100mVpp	50mVpp	1500mVpp	1500mVpp
Overload Behaviour	continuous current	selectable <sup>C)</sup>	continuous current	selectable <sup>C)</sup>	continuous current	continuous current	Fuse-mode <sup>D)</sup>	Fuse-mode <sup>D)</sup>
AC Input Voltage	nom. 3AC 380-480V -15%/+20%	3AC 400-500V ±15%	3AC 380-480V ±15%	3AC 400-500V ±15%	3AC 380-480V -15%/+20%	3AC 400-500V ±15%	3AC 400V ±15%	3AC 480V ±15%
2-Phase-Operation	100% <sup>A)</sup>	100% <sup>A)</sup>	75% <sup>A)</sup>	75% <sup>A)</sup>	50% <sup>A)</sup>	60% <sup>A)</sup>	0% <sup>A)</sup>	0% <sup>A)</sup>
Input Current <sup>3)</sup>	max. 0.7A	0.8A	0.9A	1.7A	1.8A	3A	1.65A	1.4A
Harmonic Correction <sup>8)</sup>	PFC inductor	PFC inductor	active	PFC inductor	active	PFC inductor	active	active
EN 61000-3-2 (PFC Norm)	fulfilled	fulfilled	fulfilled	fulfilled	fulfilled	fulfilled	fulfilled	fulfilled
Power Factor 400/480Vac <sup>1)</sup>	typ. 0.53/0.52	0.5/0.47	0.94/0.95	0.55/0.52	0.88/0.90	0.55/0.52	0.93/-	-/0.93
Hold-Up Time 400/480Vac <sup>1)</sup>	typ. 34/54ms	34/55ms	22/22ms	13/23ms	25/25ms	16/30ms	3ms <sup>F)</sup> /-	-/3ms <sup>F)</sup>
Input Inrush Current Limiter	active	passive <sup>R)</sup>	active	passive <sup>R)</sup>	active	active	active <sup>E)</sup>	active <sup>E)</sup>
Input Inrush Current 400Vac <sup>5)</sup>	typ. 4A; 0.5A <sup>2s</sup>	15A; 0.3A <sup>2s</sup>	3A; 1A <sup>2s</sup>	6A; 1A <sup>2s</sup>	4.5A; 1.5A <sup>2s</sup>	23A; 3A <sup>2s</sup>	2A; 5A <sup>2s</sup>	-
Input Inrush Current 480Vac <sup>5)</sup>	typ. 4A; 0.5A <sup>2s</sup>	15A; 0.4A <sup>2s</sup>	3A; 1A <sup>2s</sup>	6A; 1A <sup>2s</sup>	4.5A; 1.5A <sup>2s</sup>	27A; 3A <sup>2s</sup>	-	2A; 5A <sup>2s</sup>
External Input Circuit Breaker <sup>4)</sup>	min. B-6A; C-4A	B-10A; C-4A	B-6A; C-3A	B-10A; C-6A	B-6A; C-6A	B-10A; C-6A	B-6A; C-3A	B-6A; C-3A
DC Input Voltage	nom. DC 600V <sup>S) T) U)</sup> -25%/+30%	DC 600V <sup>S) T) U)</sup> -25%/+35%	DC 600V <sup>S) T) U)</sup> -25%/+30%	DC 600V <sup>S) T) U)</sup> -25%/+35%	DC 600V <sup>S) T) U)</sup> -25%/+35%	DC 600V <sup>S) T) U)</sup> -25%/+35%	DC 540V <sup>S) T) U)</sup> ±15%	DC 650V <sup>S) T) U)</sup> ±15%
Efficiency 400/480Vac <sup>1)</sup>	typ. 92.8/92.9%	91.9/92.1%	95.0/94.8%	92.2/92.2%	95.3/95.2%	92.6/92.8%	95.5%/-	-/95.5%
Power Losses 400/480Vac <sup>1)</sup>	typ. 18.6/18.3W	24.2/23.7W	25.3/26.6W	41.3/41.3W	47.3/48.4W	77.4/74.5W	45.2W/-	-/45.2W
MTBF <sup>6)</sup>	typ. 975 kh	1362 kh	501 kh	1120 kh	375 kh	844 kh	543 kh	561 kh
Operational Temperature Range	min. -25°C to +70°C	0°C to +70°C	-25°C to +70°C	0°C to +70°C	-25°C to +70°C	0°C to +70°C	-25°C bis +70°C	-25°C to +70°C
Derating +60°C to +70°C	min. 6W/°C	6W/°C	12W/°C	12W/°C	24W/°C	24W/°C	24W/°C	24W/°C
Dimensions WxHxD <sup>7)</sup>	nom. 62x124x117mm	89x124x117mm	65x124x127mm	150x124x121mm	110x124x127mm	275x124x117mm	96x124x157mm	96x124x157mm
Connection Terminals	screw terminals	screw terminals	spring terminals	screw terminals	screw terminals	screw terminals	screw terminals	screw terminals
Weight	max. 750g	980g	870g	1800g	1500g	3300g	1400g	1400g
DC-OK-Signal	no	no	yes <sup>P)</sup>	no	yes <sup>P)</sup>	yes <sup>O)</sup>	no	no
Parallel Use	yes <sup>N)</sup>	yes <sup>N)</sup>	yes	yes <sup>N)</sup>	yes <sup>N)</sup>	yes <sup>N)</sup>	no	no
Series Connection <sup>9)</sup>	yes	yes	yes	yes	yes	yes	yes	yes
Bracket for Wall/Panel Mounting	ZM1.WALL	SLZ02	ZM1.WALL	SLZ02	ZM2.WALL	SLZ02	ZM2.WALL	ZM2.WALL
Bracket for Side Mounting	ZM13.SIDE	-	ZM14.SIDE	-	-	-	-	-
Special Features					with shut-down input	with signal-port	semi-regulated power supply <sup>O)</sup>	semi-regulated power supply <sup>O)</sup>
Order Number	CT10.241	SL10.300 SL10.309*)	QT20.241 QT20.241-C1*)	SL20.310	QT40.241	SL40.301	XT40.241	XT40.242

\*) With conformal coated PC-board. <sup>Q)</sup> A functional description of semi-regulated power supplies can be found on page 48.  
<sup>‡)</sup> Not adjustable and for output currents > 5% of the nominal current. Below 5%, a slightly higher output voltage is possible.  
 Fold out the back page to find the appropriate footnotes.  
 Information regarding standards and approvals can be found on pages 42 to 44.  
 Visit [www.pulspower.com](http://www.pulspower.com) for detailed datasheets.





## 3-Phase Power Supplies with Output Voltages other than 24V

Drive systems especially benefit from higher supply voltages and achieve better dynamic performance. Large electrolytic output capacitors help in acceleration and absorbing back-fed power in motor applications.

3-Phase Power Supplies Output: 12V, 36-72V	12V				48V				72V			
	8A	13.3A	26.6A	26.6A	5A	10A	20A	20A	20A	13.3A	13.3A	
Family	DIMENSION-C				DIMENSION-C				DIMENSION-X			
Output Voltage	nom. 12-15V	36-42V	36V ±2% †)	36V ±2% †)	48-56V	48-55V	48-54V	48V ±2% †)	48V ±2% †)	72V ±2% †)	72V ±2% †)	
Output Current continuous	nom. 8-6.4A	13.3-11.4A	26.3A	26.3A	5-4.3A	10-8.7A	20-17.8A	20A	20A	13.3A	13.3A	
Output Current short-term	-	20-17.1A <sup>K)</sup>	33.3A <sup>H)</sup>	33.3A <sup>H)</sup>	6-5.2A <sup>L)</sup>	15-13A <sup>K)</sup>	30-26.7A <sup>K)</sup>	25A <sup>H)</sup>	25A <sup>H)</sup>	16.7A <sup>H)</sup>	16.7A <sup>H)</sup>	
Output Power continuous	nom. 96W	480W	960W	960W	240W	480W	960W	960W	960W	960W	960W	
Output Power short-term	-	720W <sup>K)</sup>	1200W <sup>H)</sup>	1200W <sup>H)</sup>	288W <sup>L)</sup>	720W <sup>K)</sup>	1440W <sup>K)</sup>	1200W <sup>H)</sup>	1200W <sup>H)</sup>	1200W <sup>H)</sup>	1200W <sup>H)</sup>	
Power Reserves	min. -	+50% BonusPower <sup>®K)</sup>	+25% BonusPower <sup>®H)</sup>	+25% BonusPower <sup>®H)</sup>	+20% Power Boost <sup>L)</sup>	+50% BonusPower <sup>®K)</sup>	+50% BonusPower <sup>®K)</sup>	+25% BonusPower <sup>®H)</sup>	+25% BonusPower <sup>®H)</sup>	+25% BonusPower <sup>®H)</sup>	+25% BonusPower <sup>®H)</sup>	
Factory Setting <sup>1)</sup>	typ. 12.0V	36.0V	36.0V	36.0V	48.0V	48.0V	48.0V	48.0V	48.0V	72.0V	72.0V	
Ripple & Noise Voltage <sup>2)</sup>	max. 100mVpp	100mVpp	2000mVpp	2000mVpp	100mVpp	100mVpp	150mVpp	2500mVpp	2500mVpp	3000mVpp	3000mVpp	
Overload Behaviour	continuous current	continuous current	Fuse-mode <sup>D)</sup>	Fuse-mode <sup>D)</sup>	continuous current	cont. current	continuous current	Fuse-mode <sup>D)</sup>	Fuse-mode <sup>D)</sup>	Fuse-mode <sup>D)</sup>	Fuse-mode <sup>D)</sup>	
AC Input Voltage	nom. 2AC 380-480V -15%/+20%	3AC 380-480V ±15%	3AC 400V ±15%	3AC 480V ±15%	3AC 380-480V -15%/+20%	3AC 380-480V ±15%	3AC 380-480V -15%/+20%	3AC 400V ±15%	3AC 480V ±15%	3AC 400V ±15%	3AC 480V ±15%	
2-Phase-Operation	100% <sup>A)</sup>	75% <sup>A)</sup>	0% <sup>A)</sup>	0% <sup>A)</sup>	100% <sup>A)</sup>	75% <sup>A)</sup>	50% <sup>A)</sup>	0% <sup>A)</sup>	0% <sup>A)</sup>	0% <sup>A)</sup>	0% <sup>A)</sup>	
Input Current <sup>3)</sup>	max. 0.64A	0.9A	1.65A	1.4A	0.7A	0.9A	1.8A	1.65A	1.4A	1.65A	1.4A	
Harmonic Correction <sup>8)</sup>	PFC inductor	active	active	active	PFC inductor	active	active	active	active	active	active	
EN 61000-3-2 (PFC Norm)	fulfilled	fulfilled	fulfilled	fulfilled	fulfilled	fulfilled	fulfilled	fulfilled	fulfilled	fulfilled	fulfilled	
Power Factor 400/480Vac <sup>1)</sup>	typ. 0.44/0.42	0.94/0.95	0.93/-	-/0.93	0.53/0.52	0.94/0.95	0.88/0.90	0.93/-	-/0.93	0.93/-	-/0.93	
Hold-Up Time 400/480Vac <sup>1)</sup>	typ. 33/58ms	22/22ms	3ms <sup>F)</sup> /-	-/3ms <sup>F)</sup>	34/54ms	22/22ms	25/25ms	3ms <sup>F)</sup> /-	-/3ms <sup>F)</sup>	3ms <sup>F)</sup> /-	-/3ms <sup>F)</sup>	
Input Inrush Current Limiter	active	active	active <sup>E)</sup>	active <sup>E)</sup>	active	active	active	active <sup>E)</sup>	active <sup>E)</sup>	active <sup>E)</sup>	active <sup>E)</sup>	
Input Inrush Current 400Vac <sup>5)</sup>	typ. 4A; 0.5A <sup>2s</sup>	3A; 1A <sup>2s</sup>	2A; 5A <sup>2s</sup>	-	4A; 0.5A <sup>2s</sup>	3A; 1A <sup>2s</sup>	4.5A; 1.5A <sup>2s</sup>	2A; 5A <sup>2s</sup>	-	2A; 5A <sup>2s</sup>	-	
Input Inrush Current 480Vac <sup>5)</sup>	typ. 4A; 0.5A <sup>2s</sup>	3A; 1A <sup>2s</sup>	-	2A; 5A <sup>2s</sup>	4A; 0.5A <sup>2s</sup>	3A; 1A <sup>2s</sup>	4.5A; 1.5A <sup>2s</sup>	-	2A; 5A <sup>2s</sup>	-	2A; 5A <sup>2s</sup>	
External Input Circuit Breaker <sup>4)</sup>	min. B-6A; C-4A	B-6A; C-3A	B-6A; C-3A	B-6A; C-3A	B-6A; C-4A	B-6A; C-3A	B-6A; C-6A	B-6A; C-3A	B-6A; C-3A	B-6A; C-3A	B-6A; C-3A	
DC Input Voltage	nom. DC 600V <sup>S) T) U)</sup> -25%/+30%	DC 600V <sup>S) T) U)</sup> -25%/+30%	DC 540V <sup>S) T) U)</sup> ±15%	DC 650V <sup>S) T) U)</sup> ±15%	DC 600V <sup>S) T) U)</sup> -25%/+35%	DC 600V <sup>S) T) U)</sup> -25%/+30%	DC 600V <sup>S) T) U)</sup> -25%/+35%	DC 540V <sup>S) T) U)</sup> ±15%	DC 650V <sup>S) T) U)</sup> ±15%	DC 540V <sup>S) T) U)</sup> ±15%	DC 650V <sup>S) T) U)</sup> ±15%	
Efficiency 400/480Vac <sup>1)</sup>	typ. 85.4/85.8%	94.8/94.6%	95.5%/-	-/95.5%	92.8/92.9%	95.4/95.0%	95.4/95.2%	96.0%/-	-/96.0%	95.5%/-	-/95.5%	
Power Losses 400/480Vac <sup>1)</sup>	typ. 16.4/15.9W	26.3/27.4W	45.2W/-	-/45.2W	18.6/18.3W	23.1/25.3W	46.3/48.4W	40.0W/-	-/40.0W	45.2W/-	-/45.2W	
MTBF <sup>6)</sup>	typ. 983 kh	492 kh	565 kh	534 kh	975 kh	531 kh	395 kh	540 kh	554 kh	595 kh	578 kh	
Operational Temperature Range	min. -25°C to +70°C	-25°C to +70°C	-25°C to +70°C	-25°C to +70°C	-25°C to +70°C	-25°C to +70°C	-25°C to +70°C	-25°C to +70°C	-25°C to +70°C	-25°C to +70°C	-25°C to +70°C	
Derating +60°C to +70°C	min. 2.5W/°C	12W/°C	24W/°C	24W/°C	6W/°C	12W/°C	24W/°C	24W/°C	24W/°C	24W/°C	24W/°C	
Dimensions WxHxD <sup>7)</sup>	nom. 40x124x117mm	65x124x127mm	96x124x157mm	96x124x157mm	62x124x117mm	65x124x127mm	110x124x127mm	96x124x157mm	96x124x157mm	96x124x157mm	96x124x157mm	
Connection Terminals	screw terminals	spring terminals	screw terminals	screw terminals	screw terminals	spring terminals	screw terminals	screw terminals	screw terminals	screw terminals	screw terminals	
Weight	max. 500g	870g	1400g	1400g	750g	870g	1500g	1400g	1400g	1400g	1400g	
DC-OK-Signal	no	yes <sup>P)</sup>	no	no	no	yes <sup>P)</sup>	yes <sup>P)</sup>	no	no	no	no	
Parallel Use	yes <sup>M)</sup>	yes	no	no	yes <sup>N)</sup>	yes	yes <sup>N)</sup>	no	no	no	no	
Series Connection <sup>9)</sup>	yes	yes	yes	yes	yes	yes	yes	yes	yes	yes	yes	
Bracket for Wall/Panel Mounting	ZM1.WALL	ZM1.WALL	ZM2.WALL	ZM2.WALL	ZM1.WALL	ZM1.WALL	ZM2.WALL	ZM2.WALL	ZM2.WALL	ZM2.WALL	ZM2.WALL	
Bracket for Side Mounting	ZM12.SIDE	ZM14.SIDE	-	-	ZM13.SIDE	ZM14.SIDE	-	-	-	-	-	
Special Features	1-Ph 400/480V input		semi-regulated power supply <sup>O)</sup>	semi-regulated power supply <sup>O)</sup>			with shut-down input	semi-regulated power supply <sup>O)</sup>	semi-regulated power supply <sup>O)</sup>	semi-regulated power supply <sup>O)</sup>	semi-regulated power supply <sup>O)</sup>	
<b>Order Number</b>	<b>CT5.121</b>	<b>QT20.361</b>	<b>XT40.361</b>	<b>XT40.362</b>	<b>CT10.481</b>	<b>QT20.481</b>	<b>QT40.481</b>	<b>XT40.481</b>	<b>XT40.482</b>	<b>XT40.721</b>	<b>XT40.722</b>	

◇) A functional description of semi-regulated power supplies can be found on page 48.

‡) Not adjustable and for output currents > 5% of the nominal current. Below 5%, a slightly higher output voltage is possible. Fold out the back page to find the appropriate footnotes.

Information regarding standards and approvals can be found on pages 42 to 44. Visit [www.pulspower.com](http://www.pulspower.com) for detailed datasheets.

## DC/DC Converters for 120V, 220V and 600V DC-Bus Voltages

Such DC voltages are common in drive systems, in mobile applications, inductive power transfer systems or systems which are supplied from 120V or 220V back-up batteries.

DC/DC Converter		Input DC 600V
		<b>24V 20A</b>
<b>Family</b>		<b>DIMENSION-Q</b>
<b>Output Voltage</b>	nom.	<b>24-28V</b>
Output Current	continuous nom.	20-17.5A
Output Current	short-term	25-21.4A <sup>K)</sup>
Output Power	continuous nom.	480W
Output Power	short-term	600W <sup>K)</sup>
Power Reserves	min.	+25% BonusPower <sup>®</sup> <sup>K)</sup>
Factory Setting <sup>1)</sup>	typ.	24.1V
Ripple & Noise Voltage <sup>2)</sup>	max.	100mVpp
Overload Behaviour		continuous current
<b>Input</b>	nom.	<b>DC 600V</b>
Input Voltage Range		480-840Vdc 360-960Vdc <sup>*)</sup>
Input Current <sup>3)</sup>	max.	1.0A
Hold-Up Time <sup>1)</sup>	typ.	22ms
Input Inrush Current Limiter		active
Input Inrush Current <sup>5)</sup>	typ.	negligible
Efficiency <sup>1)</sup>	typ.	94.5%
Power Losses <sup>1)</sup>	typ.	25.2W
MTBF <sup>6)</sup>	typ.	446 kh
Operational Temperature Range	min.	-25°C to +70°C
Derating +60°C to +70°C	min.	12W/°C
Dimensions WxHxD <sup>7)</sup>	nom.	65x124x127mm
Connection Terminals		spring terminals
Weight	max.	890g
Input / Output Isolation		yes
DC-OK-Signal		yes <sup>P)</sup>
Input-Low Signal		no
Parallel Use		yes
Series Connection <sup>9)</sup>		yes
Bracket for Wall/Panel Mounting		ZM1.WALL
Bracket for Side Mounting		ZM14.SIDE
Special Features		
<b>Order Number</b>		<b>QTD20.241</b>

<sup>\*)</sup> See datasheet for details  
 Fold out the back page to find the appropriate footnotes.  
 Infos regarding standards and approvals can be found on pages 42 to 44.  
 Visit [www.pulspower.com](http://www.pulspower.com) for detailed datasheets.

### Input: 85Vdc, 120Vdc, 220Vdc:

Many AC-power supplies can also be powered from this DC voltage. For example: all DIMENSION QS-series units can be powered from a DC voltage between 88V and 375Vdc. Further information can be found in the individual product tables in this catalogue.

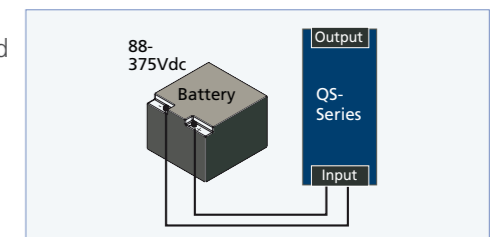

### Input: 600Vdc

The QTD20.241 is a 24V-power-supply which is specially designed for the 600V intermediate-DC-bus of drive systems and frequency converters. Connecting the power supply of the 24V control voltage to the intermediate-DC-bus and not to the AC mains offers the following advantage. In case of a mains outage, the motor acts as a generator and keeps the DC-bus voltage alive until the motor stops spinning. The voltage that supplies the controls and brakes is ensured as long as the motor is spinning. Intermediate buses are usually not filtered. The frequency converters in a drive system, the cables to the motor and the motor itself generate high common mode noises which appear on the DC terminals where the power supply is supposed to be connected. This high EMI noise requires power supplies with a rugged input stage. Regular AC-power supplies can malfunction or be damaged in such cases.

The QTD20 incorporates hardened input filters which can cope with these problems. Additionally, the QTD20 is equipped with two input fuses which are rated for 600Vdc. The unit is also UL Listed.

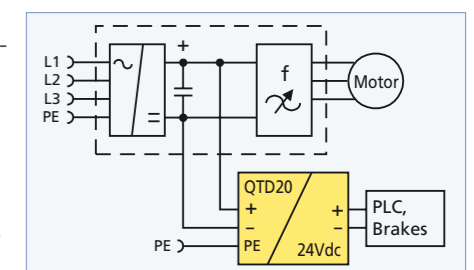



CD5.241-S1  
Signal outputs report a discharged battery or a fault in the output voltage of the unit.

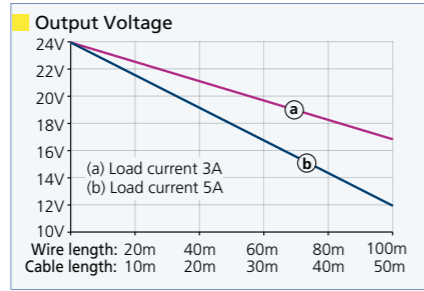

Typical voltage drop on a 0.75mm<sup>2</sup> (AWG 18) wire: The DC/DC converter can "refresh" the voltage at the end of long cable runs.

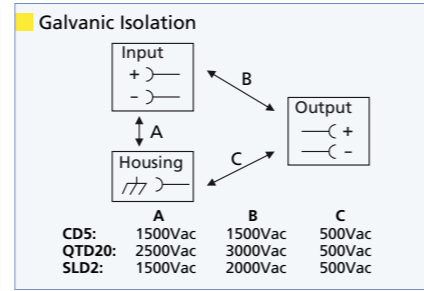

High galvanic isolation between input and output.

## DC/DC Converters for the 12V, 24V and 48V DC-Bus

The field of applications for these units is very wide: stabilised control voltages in battery powered applications, in mobile applications such as ships, fork-lifts, trucks, for galvanic isolation to avoid earth (ground) loops or to restore the 24V control voltage at the end of long cable runs to compensate for voltage drops.

DC/DC Converter	12V Input		24V Input				48V Input	
	24V 4A	5V 8A	12V 8A	24V 3.8A	24V 5A	24V 5A	24V 5A	
Family	DIMENSION-C	SilverLine	DIMENSION-C	DIMENSION-C	DIMENSION-C	DIMENSION-C	DIMENSION-C	
Output Voltage	nom. 24-28V	5-5.5V	12-15V	24V	23-28V	23-28V	23-28V	
Output Current continuous	nom. 4-3.4A	8A	8-6.4A	3.8A	5-4.3A	5-4.3A	5-4.3A	
Output Current short-term	4.8-4.1A <sup>1)</sup>	-	9.6-7.7A <sup>1)</sup>	-	6-5.1A <sup>1)</sup>	6-5.1A <sup>1)</sup>	6-5.1A <sup>1)</sup>	
Output Power continuous	nom. 96W	40W	96W	92W	120W	120W	120W	
Output Power short-term	116W <sup>1)</sup>	-	116W <sup>1)</sup>	-	144W <sup>1)</sup>	144W <sup>1)</sup>	144W <sup>1)</sup>	
Power Reserves	min. +20% Power Boost <sup>1)</sup>	-	+20% Power Boost <sup>1)</sup>	-	+20% Power Boost <sup>1)</sup>	+20% Power Boost <sup>1)</sup>	+20% Power Boost <sup>1)</sup>	
Factory Setting <sup>1)</sup>	typ. 24.1V	5.1V	12.0V	24.1V	24.1V	24.1V	24.1V	
Ripple & Noise Voltage <sup>2)</sup>	max. 50mVpp	50mVpp	75mVpp	50mVpp	50mVpp	50mVpp	50mVpp	
Overload Behaviour	continuous current	continuous current	continuous current	continuous current	continuous current	continuous current	continuous current	
Input	nom. DC 12V	DC 24V	DC 24V	DC 24V	DC 24V	DC 24V	DC 48V	
Input Voltage Range	8.4-16.2Vdc	18-36Vdc	18-32.4Vdc 14-35Vdc <sup>*)</sup>	14-32.4Vdc 14-35Vdc <sup>*)</sup>	18-32.4Vdc 14-35Vdc <sup>*)</sup>	18-32.4Vdc 14-35Vdc <sup>*)</sup>	36-60Vdc	
Input Current <sup>3)</sup>	max. 12A	2.9A	5.6A	5.5A	7A	7A	3.5A	
Hold-Up Time <sup>1)</sup>	typ. 3ms	12ms	7ms	7ms	6ms	6ms	6ms	
Input Inrush Current Limiter	active	active	active	active	active	active	active	
Input Inrush Current <sup>5)</sup>	typ. negligible	5A; 1.5A <sup>2)</sup>	negligible	negligible	negligible	negligible	negligible	
Efficiency <sup>1)</sup>	typ. 87.7%	82.0%	88.2%	90.5%	90.3%	90.2%	90.3%	
Power Losses <sup>1)</sup>	typ. 13.5W	8.8W	12.8W	9.7W	12.9W	13.3W	12.9W	
MTBF <sup>6)</sup>	typ. 1100 kh	1785 kh	1161 kh	1178 kh	1178 kh	1048 kh	951 kh	
Operational Temperature Range	min. -25°C to +70°C	0°C to +70°C	-25°C to +70°C	-25°C to +70°C	-25°C to +70°C	-25°C to +70°C	-25°C to +70°C	
Derating +60°C to +70°C	min. 2.5W/°C	1.5W/°C	2.5W/°C	0W/°C	3W/°C	3W/°C	3W/°C	
Dimensions WxHxD <sup>7)</sup>	nom. 32x124x102mm	49x124x102mm	32x124x102mm	32x124x102mm	32x124x102mm	32x124x102mm	32x124x102mm	
Connection Terminals	screw terminals	screw terminals	screw terminals	spring terminals	screw terminals	spring terminals	screw terminals	
Weight	max. 435g	470g	425g	425g	425g	450g	425g	
Input / Output Isolation	yes	yes	yes	yes	yes	yes	yes	
DC-OK-Signal	no	no	no	no	no	yes <sup>P)</sup>	no	
Input-Low Signal	no	no	no	no	no	yes <sup>P)</sup>	no	
Parallel Use	yes <sup>M)</sup>	yes	yes <sup>M)</sup>	no	yes <sup>M)</sup>	yes <sup>M)</sup>	yes <sup>M)</sup>	
Series Connection <sup>9)</sup>	yes	no	yes	no	yes	yes	yes	
Bracket for Wall/Panel Mounting	ZM1.WALL	SLZ02	ZM1.WALL	ZM1.WALL	ZM1.WALL	ZM1.WALL	ZM1.WALL	
Bracket for Side Mounting	ZM11.SIDE	-	ZM11.SIDE	ZM11.SIDE	ZM11.SIDE	ZM11.SIDE	ZM11.SIDE	
Special Features				NEC-Class-2			optimised for mobile or battery powered applications	
Order Number	CD5.243	SLD2.100	CD5.121	CD5.241-L1	CD5.241	CD5.241-S1	CD5.242	

\*) See datasheet for details.  
Fold out the back page to find the appropriate footnotes.  
Information regarding standards and approvals can be found on pages 42 to 44.  
Visit [www.pulspower.com](http://www.pulspower.com) for detailed datasheets.







## AS-Interface® Power Supplies and DC/DC Converters

The AS-Interface® field bus system is a network technology where power and data are provided by the same single two-conductor wire. Therefore, special power supplies with an output voltage of 30.6V and an integrated data-decoupling circuit are required which prevents the modulated signal voltage on the AS-Interface® bus from being corrupted. The outputs of these power supplies are inductive and are not suitable for other purpose.

AS-Interface® Power Supplies	1-Phase			3-Phase	DC/DC
	30.6V 2.8A	30.6V 4A	30.6V 8A	30.6V 8A	30.6V 4A
Family	SilverLine	SilverLine	SilverLine	SilverLine	SilverLine
Output Voltage	nom. 30.6V	30.6V	30.6V	30.6V	30.6V
Tolerance	±3%	±3%	±3%	±3%	±3%
Output Current	nom. 2.8A	4A	8A	8A	4A
Output Power	nom. 85W	120W	240W	240W	120W
Ripple & Noise Voltage <sup>2)</sup>	max. 50mVpp	50mVpp	50mVpp	50mVpp	50mVpp
Overload Behaviour	continuous current	continuous current	Fuse-mode	Fuse-mode	continuous current
Input Voltage	nom. AC 100-120/200-240V #)	AC 100-120/200-240V #)	AC 100-120/200-240V #)	3AC 400-500V ±15%	DC 24V 18-32.4Vdc 14-35Vdc *)
Input Current <sup>3)</sup>	max. 2.0A/0.9A	2.7A/1.3A	6.0A/2.8A	0.8A	7A
Harmonic Correction <sup>8)</sup>	-	-	-	PFC inductor	-
EN 61000-3-2 (PFC Norm)	fulfilled	fulfilled	not fulfilled	fulfilled	not applicable
Power Factor <sup>1)</sup>	typ. 0.58/0.53	0.58/0.53	0.53/0.48	0.5/0.47	-
Hold-Up Time <sup>1)</sup>	typ. 55/58ms	56/60ms	26/28ms	30/50ms	6ms
Input Inrush Current Limiter	NTC	NTC	active	NTC	active
Input Inrush Current 120 or 400Vac <sup>5)</sup>	typ. 18A; 1.4A <sup>2</sup> s	45A; 3.7A <sup>2</sup> s	14A; 1.5A <sup>2</sup> s	45A; 1.4A <sup>2</sup> s	negligible
Input Inrush Current 230 or 480Vac <sup>5)</sup>	typ. 32A; 1.6A <sup>2</sup> s	50A; 2.5A <sup>2</sup> s	26A; 1.5A <sup>2</sup> s	54A; 2.3A <sup>2</sup> s	negligible
External Input Circuit Breaker <sup>4)</sup>	min. B-10A; C-6A	B-10A; C-6A	B-10A; C-6A	B-10A; C-4A	-
DC Input Voltage	nom. DC 270-300V <sup>5) 7)</sup> -15%/+25%	DC 280-300V <sup>5) 7)</sup> -15%/+25%	DC 270-300V <sup>5) 7)</sup> -15%/+25%	DC 600V <sup>5) 7) 8)</sup> -25%/+35%	18-32.4Vdc 14-35Vdc *)
Efficiency <sup>1)</sup>	typ. 89.5/90.5%	89.0/90.0%	91.0/92.0%	91.5/91.6%	90.5%
Power Losses <sup>1)</sup>	typ. 10.5/9.1W	14.9/13.5W	23.7/21.2W	22.5/22.0W	12.7W
MTBF <sup>6)</sup>	typ. 1942 kh	1222 kh	869 kh	1220 kh	1247 kh
Operational Temperature Range	min. -10°C to +70°C	-10°C to +70°C	-10°C to +70°C	-10°C to +70°C	-25°C to +70°C
Derating +60°C to +70°C	min. 2W/°C	3W/°C	6W/°C	6W/°C	3W/°C
Dimensions WxHxD <sup>7)</sup>	nom. 49x124x102mm	73x124x102mm	91x124x102mm	129x124x117mm	40x124x102mm
Connection Terminals	screw terminals	screw terminals	screw terminals	screw terminals	screw terminals
Weight	max. 500g	650g	890g	1160g	500g
Ground-Fault Monitor	no	yes	no	no	no
IR- Addressing Mode	yes	yes	yes	yes	no
Parallel Use	no	no	no	no	no
Series Connection <sup>9)</sup>	no	no	no	no	no
Bracket for Wall/Panel Mounting	SLZ02	SLZ02	SLZ02	SLZ02	ZM1.WALL
Bracket for Side Mounting	-	-	-	-	ZM12.SIDE
Special Features		ground-fault monitor included			
<b>Order Number</b>	<b>SLA3.100</b>	<b>SLA4.100</b>	<b>SLA8.100</b>	<b>SLA8.300</b>	<b>SLAD4.100</b>

\*) See datasheet for details. <sup>1)</sup> Valid for 120/230Vac, 400/480Vac or 24Vdc (depending on the unit) and nominal load, <sup>2)</sup> Manual-select by slide-switch  
Fold out the back page to find the appropriate footnotes.  
Information regarding standards and approvals can be found on pages 42 to 44.  
Visit [www.pulspower.com](http://www.pulspower.com) for detailed datasheets.

### Protection:

To protect the relatively thin AS-Interface®-cable the 8A units are equipped with an electronic fuse which switches off the output in an overload situation. The output of the 4A power supply has an integrated ground fault monitor included which reports unsafe communication. The 2.8A unit fulfills the NEC Class 2 requirement which is important for applications within the USA.

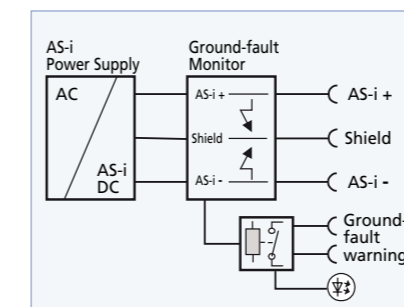

SLA4.100 with ground-fault monitor for early failure recognition.

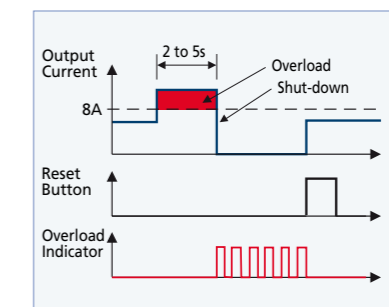

FUSE-Mode: All 8A units are equipped with an electronic fuse which switches off the output in an overload situation.

### Fast addressing of slaves:

The "IR addressing mode" is selectable via a jumper and interrupts the data communication on the yellow AS-Interface®-cable. During this process, the slaves are still supplied with voltage and can be programmed locally with the infrared interface. This saves a lot of time during installation and service work.



Easy commissioning: Supports addressing via infrared programming device.

### DC/DC converter:

Brand new: The 4A DC/DC converter for the AS-Interface® system, which can be supplied from the regular 24V-bus voltage. This means that hazardous power line voltages can be avoided on machines. Furthermore, large voltage drops on long cable runs can be restored. This converter provides the required AS-Interface® voltage and has a data-decoupling circuit included.



**SLAD4.100** DC/DC converter with 24V input voltage for decentralized applications.

## DC-UPS's

A DC-UPS (DC- Uninterruptible Power Supply) is a supplementary device for regulated power supplies and can bridge voltage interruptions on 24V-buses. The energy storage element is one external or integrated VRLA battery. The unique feature of the PULS DC-UPS is the "1-Battery-Concept", which achieves the longest service life for batteries. For the individual demands of different applications, several DC-UPS controller units are available. PLC's or industrial PC's only require buffering for a few minutes. Therefore, the UBC10.241 or UB10.241 in combination with small batteries provide an optimal solution. Security systems and remote applications often require buffer times of up to 72 hours. For these purposes, the UB10.242 can be used with batteries up to 130Ah. A DC-UPS with an integrated 12V output is also available.

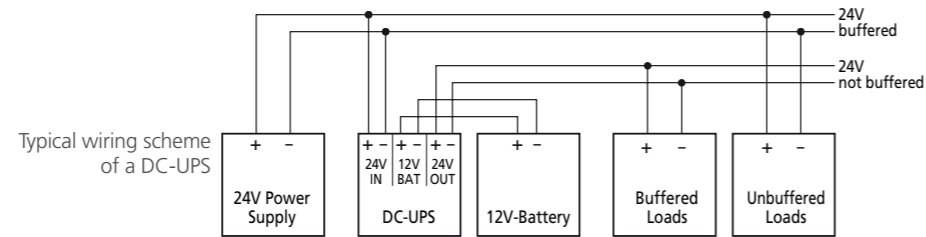

DC-UPS's	Internal Battery		External Battery		External Battery	
	24V 10A		24V 10A		24V 10A & 12V 5A	
Family	DIMENSION-U		DIMENSION-U		DIMENSION-U	
Input Voltage Range	22.5-30V		22.5-30V		22.5-30V	
Output Voltage	Normal-mode	nom.	same as input voltage #)	same as input voltage #)	same as input #)	12V±1%
Output Current	Normal-mode	nom.	15A	15A	15A ①)	5A
Output Power	Normal-mode	nom.	360W	360W	360W ①)	60W
Overload Behaviour	Normal-mode		continuous current	continuous current	cont. current	cont. current
Output Voltage	Buffer-mode	nom.	22.5V ‡)	22.5V ‡)	22.5V ‡)	12V ±1%
Output Current	Buffer-mode	continuous	nom.	10A	10A ①)	5A
	Buffer-mode	< 5s	nom.	15A	15A ①)	5A
Output Power	Buffer-mode	continuous	min.	240W	240W ①)	60W
Overload Behaviour	Buffer-mode			Shut-down after 5s	Shut-down after 5s	Shut-down > 5s
Battery			intern: 1x 12V	extern: 1x 12V	extern: 1x 12V	extern: 1x 12V
Allowed Battery Size			approx. 5Ah (90x70x106mm)	≥3.9Ah; ≤40Ah ④)	≥17Ah; ≤130Ah	≥3.9Ah; ≤40Ah ④)
Charging Current into 12V Battery		typ.	1.5A	1.5A	3.0A	1.5A
Temperature Tracking of the End-of-Charge Voltage			automatic	manual	manual / automatic	manual
Charging Time		typ.	3h	5h / 17h (7Ah / 26Ah)	9h / 34h (26Ah / 100Ah)	5h / 17h (7Ah / 26Ah)
Buffer Time	5Ah Battery	Load 24V 10A	min./typ.	4 minutes 54s / 6 minutes 15s ‡)	4 minutes 54s / 6 minutes 15s ‡)	4 minutes 45s / 6 minutes ‡)
	7Ah Battery	Load 24V 10A	Min./typ.	-	5 minutes 42s / 6 minutes 45s ‡)	5 minutes 30s / 6 minutes 30s ‡)
	26Ah Battery	Load 24V 10A	min./typ.	-	39 minutes / 55 minutes ‡)	39 minutes / 53 minutes ‡)
	100Ah Battery	Load 24V 10A	min./typ.	-	3h 5 minutes / 4h 7 minutes ‡)	-
	100Ah Battery	Load 24V 0.5A	min./typ.	-	62h / 82h ‡)	-
MTBF ⑥)		typ.	886 kh (battery excluded)	886 kh	886 kh	788 kh
Operational Temperature Range		min.	0°C to +40°C	-25°C to +70°C	-25°C to +50°C	-25°C to +70°C
Derating		min.	-	> 60°C: 0.25A/°C	-	> 50°C: 0.25A/°C
Dimensions WxHxD ⑦)		nom.	123x124x119mm	49x124x117mm	49x124x117mm	49x124x117mm
Weight		max.	2850g	530g	545g	650g
Parallel Use			no	no	no	no
Bracket for Wall/Panel Mounting			ZM1.UBC10	ZM1.WALL	ZM1.WALL	ZM1.WALL
Bracket for Side Mounting			-	-	-	-
Order Number			<b>UBC10.241</b> <b>UBC10.241-N1*)</b>	<b>UB10.241</b>	<b>UB10.242</b>	<b>UB10.245</b>

\*) UBC10.241-N1 battery not included #) Minus the input to output voltage drop, see curves on the right page.  
 ④) 40Ah are valid for units with a serial number higher than 5357527. Earlier units can be used with batteries up to 27Ah.  
 ‡) See curves on the right page and on page 37 ①) Lower when 12V-output is loaded. See datasheet for details.  
 Fold out the back page to find the appropriate footnotes.  
 Information regarding standards and approvals can be found on pages 42 to 44.  
 Visit [www.pulspower.com](http://www.pulspower.com) for detailed datasheets.



UB10.241  
DC-UPS controller for external batteries



UBC10.241  
DC-UPS with integrated battery

### DC-UPS advantages:

- Requires only one 12V-battery to buffer 24V circuits
- Easy battery replacement, no matched batteries required
- Stabilised output voltage in buffer mode
- No dips of the DC-voltage during transition from normal to buffer mode
- Superior battery management for longest battery service life
- Output is decoupled from the input to separate load circuits into buffered and non buffered sections
- Electronically overload protected
- Reverse polarity protection for battery input
- Extensive and smart diagnostics and monitoring functions
- "Replace Battery" signal included
- Selectable buffer time limiter

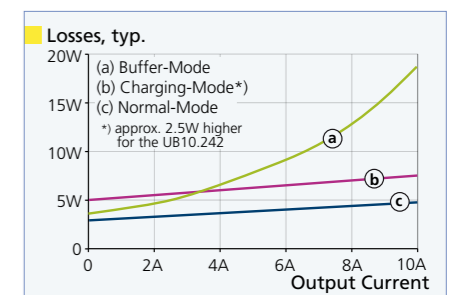
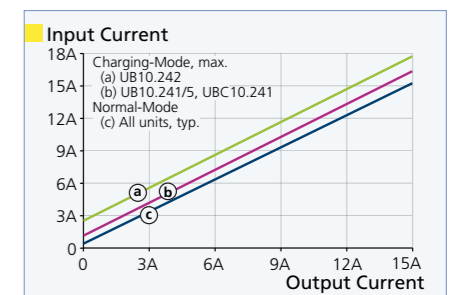
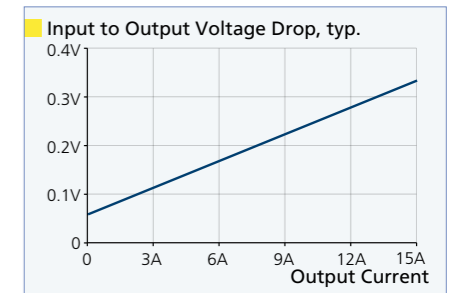
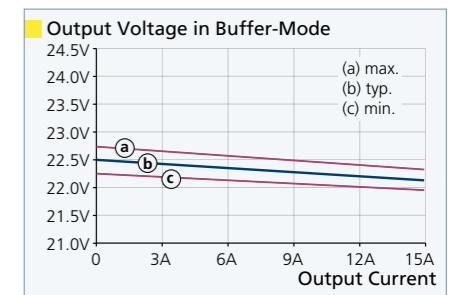
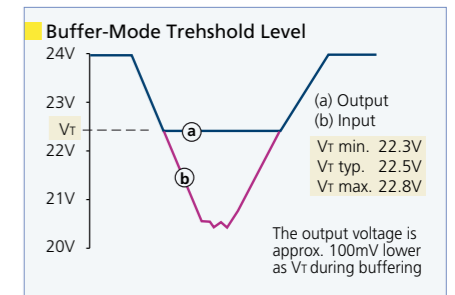

## Battery Service Life and the PULS "1-Battery-Concept"

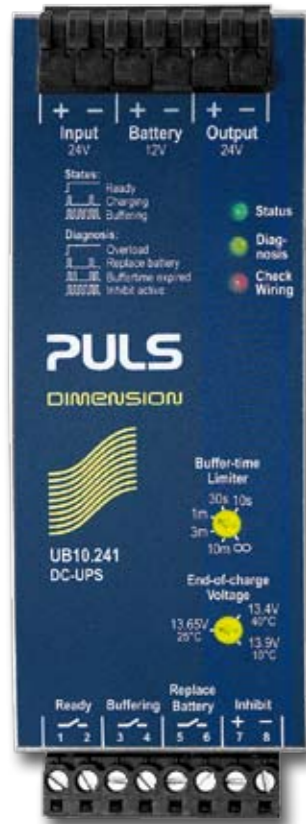

UB10.241

Boosting the 12V to a 24V level is very beneficial. The end-of-charge-voltage can be precisely set to the battery needs and the overcharging that can occur with a series connected batteries can be eliminated. Battery replacement is also easy since it is not necessary to find matched batteries. To achieve the longest battery service life, the DC-UPS can be set to the expected battery temperature which optimises the end-of-charge-voltage. It is recommended to place the batteries in cool locations and not inside hot cabinets. The UBC10.241 and the UB10.242 units also have a temperature sensor included which automatically adjusts the end-of-charge-voltage according to the ambient temperature.

### Battery monitoring

Thanks to the "1-battery-concept," defective batteries can be detected much earlier and safer than if two batteries are used in series. Various battery and wiring tests periodically monitor the battery quality and report if the battery becomes defective.

### Buffer time limiter extends battery life

Buffer only as long as you really need to. Each discharge of the battery reduces the number of discharging cycles. Therefore, the DC-UPS is equipped with a buffer time limiter, which prevents the battery from being discharged too much. The limitation can be selected with a rotary switch or be activated through the inhibit input.

### Self explanatory user interface

Many parameters are fixed or automatically adjusted. This avoids accidental misuse or unwanted manipulation of the unit.

### Diagnostic and monitoring functions

The green LED shows if the DC-UPS is in charging or in buffer mode. The yellow LED helps troubleshooting if something does not work as expected and the red LED reports if an immediate action is required (e.g. missing fuse or wiring error in the battery path). Several relay contacts are available for remote monitoring of the unit.

- Ready contact: reports correct input voltage, correct wiring and that the battery is more than about 85% charged.
- Buffering contact: DC-UPS is in buffer mode
- Replace Battery contact: reports that the battery needs to be replaced due to an unexpected battery failure or defective wiring in the battery path.

### Protection features

A comprehensive protection package is built into the DC-UPS to detect reverse polarities, incorrect battery voltage or high temperatures and avoids deep-discharging of the battery. The output is electronically protected against overload and short-circuit.

### Battery service life according to EUROBAT

The EUROBAT guideline may tempt you not to replace the batteries soon enough. The service life of batteries according to the EUROBAT guideline is valid for 20°C, exact end-of-charge voltage and without any discharging cycles. The EUROBAT number should be modified by taking the stress factors of the real application into consideration. For example, the battery life is halved when the temperature is 10°C warmer and 100 cycles are applied.

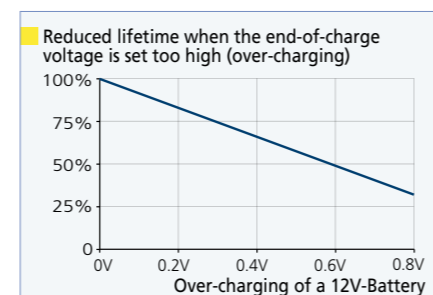
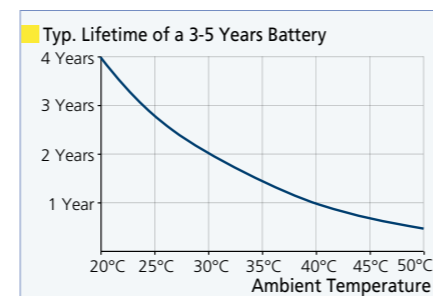
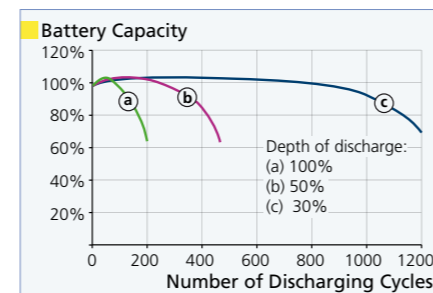

## Batteries and Battery Modules

All battery modules use maintenance-free VRLA (Valve-Regulated Lead-Acid) batteries. Battery modules are available with or without batteries included. Batteries which are not in use age much slower when they are fully charged. Therefore, PULS recharges all batteries before delivery, saving the user from having to do so. Storage of up to 9 months is possible without any further recharging. A user can purchase batteries from different suppliers. In this case check the allowed battery sizes, the maximum charging and discharging currents and ensure to incorporate a fuse (close to the battery) between the battery and the controller unit. Optionally, even car batteries can be used but the performance can deviate slightly compared to VRLA batteries.



	Battery Modules		Battery Replacements		
Battery Voltage	12V	12V	12V	12V	12V
Battery Size	7Ah	26Ah	5Ah	7Ah	26Ah
DIN-Rail Mounting	yes	no	-	-	-
Wall / Panel Mounting	yes	yes	-	-	-
Dimensions WxHxD	155x124x112mm	214x179x158mm	70x106x90mm	151x95x65mm	166x125x175mm
Weight	3200g	9920g	2000g	2700g	9300g
Operational Temp. Range	0 to +40°C	0 to +40°C	0 to +40°C	0 to +40°C	0 to +40°C
Battery Service Life **)	3-5 years	10-12 years	3-5 years	3-5 years	10-12 years
Battery Replacement for	-	-	UBC10.241	UZK12.071	UZK12.261
<b>Order Number</b>	<b>UZK12.071</b> <b>UZO12.07*)</b>	<b>UZK12.261</b> <b>UZO12.26*)</b>	<b>UZB12.051</b>	<b>UZB12.071</b>	<b>UZB12.261</b>

\*) Module without battery included

\*\*) According to EUROBAT guideline; Replacement intervals are temperature dependent, also see information on left page.

## Achievable Buffer Times:

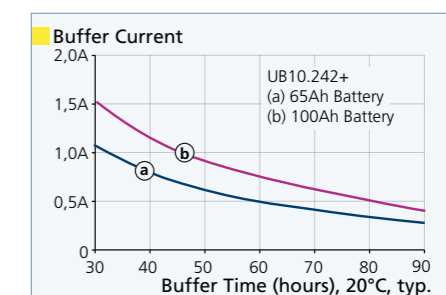
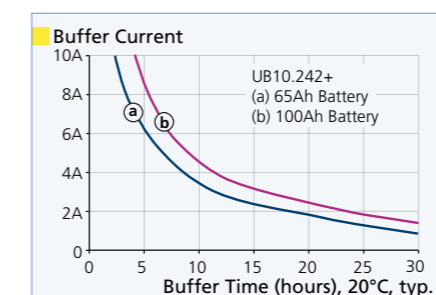
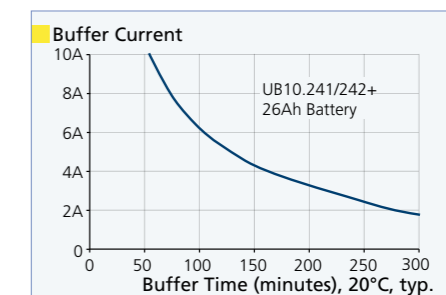
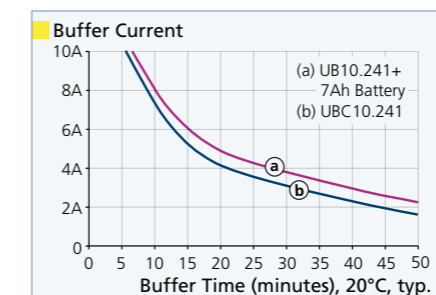

# Capacitor Buffer Modules 24V and 48V

## Capacitor Buffer Modules

Buffer modules are supplementary devices for 24Vdc or 48Vdc regulated power supplies. They deliver power to bridge failures of the DC voltage supply or extend the hold-up time after loss of the AC power. Service-free electrolytic capacitors are used for storing the energy. This allows the use even at temperatures up to 70°C. A required periodic replacement of lead-acid-batteries is not necessary for these capacitors.

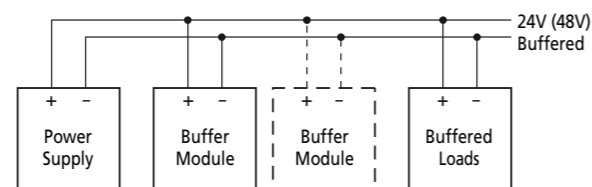

Typical wiring scheme of a buffer module. Multiple units can be used in parallel to increase the buffer current or to extend the buffer time.



Capacitor Buffer Modules	24V		48V	
	24V	20A 310ms	48V	20A 150ms
Family	DIMENSION-U		DIMENSION-U	
Input Voltage Range	nom.	24-28.8V	48-56V	
Input Current	Stand-by-mode	typ. 80mA	40mA	
	Charging-mode	max. 600mA	500mA	
Buffer-mode Transition Threshold	nom.	selectable: 22.5V fixed or variable by a voltage drop of 1V	selectable: 45V fixed or variable by a voltage drop of 2V	
Output Voltage in Buffer-mode	= threshold voltage for buffering		= threshold voltage for buffering	
Buffer Current	nom.	20A	20A	
Buffer Time	min.	200ms at 20A	100ms at 20A	
	typ.	310ms at 20A	150ms at 20A	
Power Losses in Stand-by-mode	typ.	1.9W	1.9W	
Charging Time	typ.	18s	21s	
MTBF <sup>6)</sup>	typ.	2327 kh	2348 kh	
Operational Temperature Range	min.	-25°C to +70°C	-25°C to +70°C	
Derating +60°C to +70°C	min.	-	-	
Dimensions WxHxD <sup>7)</sup>	nom.	64x124x102mm	64x124x102mm	
Connection Terminals	spring terminals <sup>*)</sup>		spring terminals	
Weight	max.	740g	740g	
Control Input	inhibit		inhibit	
Output Signals	ready, active (buffering)		ready, active (buffering)	
Parallel Use for Extended Current or Buffer Time	yes		yes	
Bracket for Wall/Panel Mounting	UF20: ZM1.WALL		ZM1.WALL	
Bracket for Side Mounting	UF20: ZM14.SIDE		ZM14.SIDE	
Storage element	built-in electrolytic capacitors		built-in electrolytic capacitors	
Order Number	UF20.241 SLV20.200*)		UF20.481	

\*) Unit in SilverLine look with power port (screw terminals) located on the bottom of the unit. Fold out the back page to find the appropriate footnotes. Information regarding standards and approvals can be found on pages 42 to 44. Visit [www.pulspower.com](http://www.pulspower.com) for detailed datasheets.

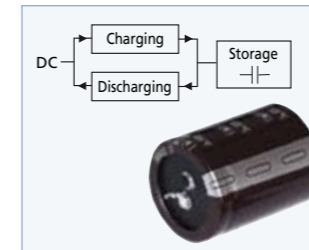

The stored energy of the electrolytic capacitors is released slowly into the load when there is a loss on the DC-bus.

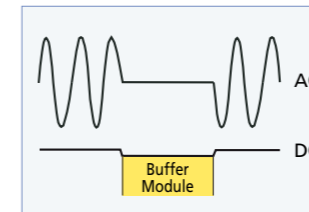

Statistically, 80% of all mains failures last less than 200ms.



The status LED reports if the unit is in ready, charging or in buffer mode.



Signal outputs and "Inhibit" input.

### Buffer module advantages:

- Energy storage with electrolytic capacitors
- No service needed for the entire life span
- Can be used up to +70°C
- Stabilised output voltage in buffer mode
- No dips of the DC voltage during transition from normal to buffer mode
- Multiple units can be used in parallel to gain a longer buffer time or to increase the buffer current
- Selectable back-up behaviour: Buffering starts below a fixed voltage or by voltage decrease of a certain number of volts. LED and transistor outputs to report the status of the unit.
- "Inhibit" input to disable buffering

### Suitable power supplies:

All 24V or 48V power supplies >15W are suitable to extend the hold-up time after loss of the AC-power or to deliver extra current to support peak load demands.

Do not use the following power supplies in combination with buffer modules for bridging short mains outages:

CD5, CS5, CS10, QS20, QS40 and SL40



UF20.241

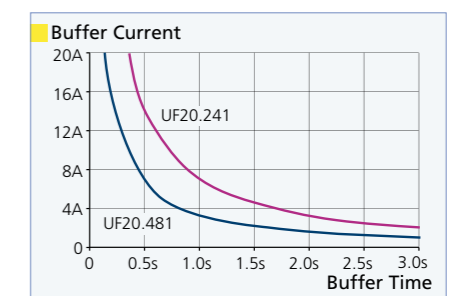



## Redundant Power Supply Systems

Redundancy Modules		Diode Modules		Redundancy Modules		
		2x 5A	2x 10A	2x 10A	2x 30A	1x 40A
Family		MiniLine	DIMENSION-Y	DIMENSION-Y	SilverLine	SilverLine
Nominal Voltage	nom.	10-60Vdc	10-60Vdc	24-60Vdc	24-28Vdc	24-28Vdc
Number of Inputs		2	2	2	2	1
Number of Outputs		1	1	1	1	1
Input Current	1+1 Mode	nom. 2x 8A	2x 12.5A	2x 12.5A	2x 30A	40A
	N+1 Mode	nom. 2x 5A	2x 10A	2x 10A	2x 15A	40A
	Single Use	nom. 10A	20A	20A	30A	40A
Output Current	Nominal	nom. 10A	20A	20A	30A	40A
	Overload	max. 16A	25A	25A	64A*)	54A
Voltage Drop	Input to Output	typ. 0.9V	0.85V	0.85V	0.5V	0.5V
	No Load	typ. 0W	0W	1W	1.6W	1.1W
Power Losses	Nominal Load	typ. 9W at 10A	17W at 20A	18W at 20A	13.2W at 30A	19.2W at 40A
	MTBF <sup>6)</sup>	typ. 85 Mio. h	47 Mio. h	9.1 Mio. h	4.7 Mio. h	5.2 Mio. h
Operational Temperature Range	min.	-40°C to +70°C	-25°C to +70°C	-25°C to +70°C	-10°C to +70°C	-10°C to +70°C
Derating +60°C to +70°C	min.	0.25A/°C	0.5A/°C	0.5A/°C	0.7A/°C	1A/°C
Dimensions WxHxD <sup>7)</sup>	nom.	45x75x91mm	32x124x102mm	32x124x117mm	48x124x102mm	48x124x117mm
Connection Terminals		spring terminals	spring terminals	screw terminals	screw terminals	screw terminals
Weight	max.	140g	290g	350g	640g	650g
Under-Voltage Monitor		no	no	21.5V	adjustable between 16 & 27V	adjustable between 16 & 27V
Over-Voltage Monitor		no	no	no	30.7V ±5%	30.7V ±5%
Alarm Signals		no	no	2 relay contacts	2 relay contacts	relay contact
Bracket for Wall/Panel Mounting		included	ZM1.WALL	ZM1.WALL	SLZ02	SLZ02
Bracket for Side Mounting		-	ZM11.SIDE	ZM11.SIDE	-	-
<b>Order Number</b>		<b>MLY02.100</b>	<b>YR2.DIODE</b>	<b>YRM2.DIODE</b>	<b>SLR02</b>	<b>SLR01</b>

\*) Above 30A, both output terminals must be used.  
 Fold out the back page to find the appropriate footnotes.  
 Information regarding standards and approvals can be found on pages 42 to 44. Visit [www.pulspower.com](http://www.pulspower.com) for detailed datasheets.

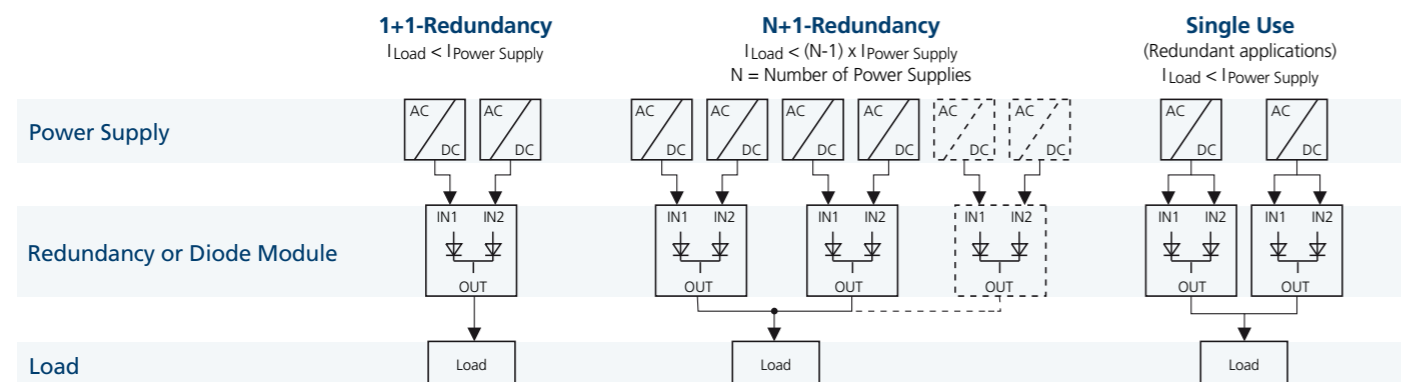

The reliability and availability of the DC voltage can be increased by using redundant systems. To achieve redundancy, one extra power supply must be installed in order to supply the required current in case one unit in the system fails. Each individual standard power supply must be isolated from the others with a diode or redundancy module. Redundant power supplies are also available which already have the decoupling diodes included.



MLY02.100 YR2.DIODE YRM2.DIODE SLR01 SLR02

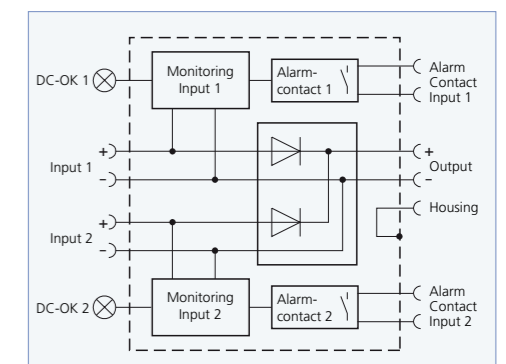

Functional diagram YRM2.DIODE

### Diode modules

Diode modules only contain decoupling diodes and are the optimal solution to use in redundant systems, when the power supply itself is already equipped with a DC-OK signal contact.

### Redundancy modules

Redundancy modules contain decoupling diodes as well as a monitoring circuit. LEDs and relay contacts signal when the input voltage of the module is not in range due to a power supply failure. This allows remote monitoring.

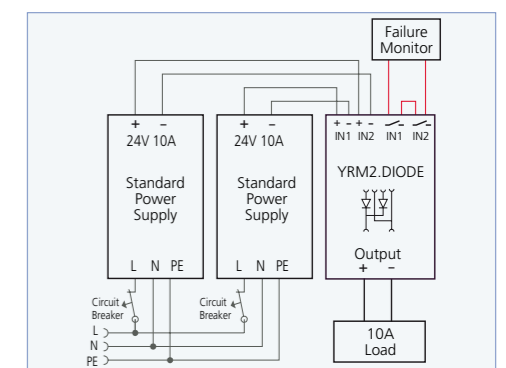

Wiring scheme of a 10A redundant system with the redundancy module YRM2.DIODE

### Parallel use of power supplies

All power supplies, even those which are not specified for parallel use in the product tables in this catalogue, can be used to build 1+1-redundancy applications. Please note that this is not valid for N+1 redundancy applications.

### Redundant power supplies

Redundant power supplies have decoupling diodes. A DC-OK signal contact and plug-connectors are also included.

- SLR2.100** 1-Phase 24V, 2.5A Page 13
- SLR5.100** 1-Phase 24V, 5A Page 15
- SLR10.100** 1-Phase 24V, 10A Page 17

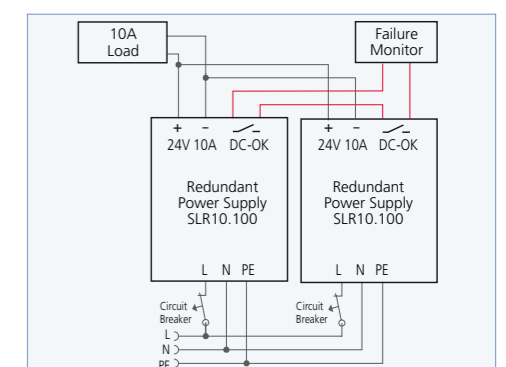

Wiring scheme of a 10A redundant system with two redundant power supplies SLR10.100



## Safety Standards

IEC 61203 / EN 50178 EN 50272-2	Electronic equipment in power installations Safety requirements for secondary batteries and battery installations – Part 2: stationary batteries
IEC/EN 60204-1	Safety of electrical equipment of machines
IEC/EN/UL 60950-1	Safety of information technology equipment
IEC/EN/UL 60601-1	Safety of medical equipment
IEC/EN 61204	Low-voltage power supply devices, DC-output
IEC/EN 61800-5	Adjustable speed electrical power drive systems – Part 5: Safety
IEC/EN 61131-2	Programmable controllers – Part 2: Equipment requirements and tests
EN 61558-2-17	Safety of power transformers for switch-mode power supplies
EN 60079-15	Electrical apparatus for explosive gas atmospheres (ATEX) – Part 15: Construction, test and marking of type of protection “n” electrical apparatus
Class I Div 2 (HazLoc)	Approval for the use in Class I Division 2 Groups A, B, C, D hazardous locations. Certification according to UL 1604 or ANSI/ISA-12.12.01
CSA 22.2 No. 107	Canadian standard: CSA C22.2 No 107.1-01 Rectifying equipment, commercial and industrial power supplies
UL 508	Industrial control equipment
UL 1310	Class 2 power units
UL 1604	Electrical equipment for use in Class I and II, Division 2 and Class III hazardous locations.
UL 61010	Standard for safety; electrical equipment for measurement, control, and laboratory use

## EMC Standards

IEC/EN 61000-3-2	EMC, Limits for harmonic current emission (“PFC-Norm”)
IEC/EN 61000-3-3	EMC, Limitation of voltage changes, voltage fluctuations and flicker
IEC/EN 61000-6-1	EMC, Generic immunity standard for residential and commercial environment
IEC/EN 61000-6-2	EMC, Generic immunity standard for industrial environment
IEC/EN 61000-6-3	EMC, Generic emission standard for residential and commercial environment
IEC/EN 61000-6-4	EMC, Generic emission standard for industrial environment
IEC/EN 61204-3	Low-voltage power supply devices, DC-output – Part 3: electromagnetic compatibility
IEC/EN 61800-3	Adjustable speed electrical power drive systems – Part 3: EMC requirements and specific test methods
EN 55011	Industrial, scientific and medical (I.S.M.) radio frequency equipment – Radio disturbance characteristics
EN 55022	Information technology equipment (I.T.E.) radio frequency equipment – Radio disturbance characteristic
EN 55024	Information technology equipment – Immunity characteristics – Limits and methods of measurement; replaced by EN 61000-6-1
EN 50081-1	Emission standard for residential and commercial environment; replaced by EN 61000-6-3
EN 50081-2	Emission standard for industrial environment; replaced by EN 61000-6-4
EN 50082-1	Immunity standard for residential and commercial environment; replaced by EN 61000-6-1
EN 50082-2	Immunity standard for industrial environment; replaced by EN 61000-6-2
FCC Part 15	Federal Communications Commission; EMC requirements for radio frequency devices

## SEMI F47

Class 2  
<100W <8A

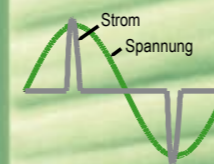

## SEMI F47

SEMI (Semiconductor Equipment and Materials International) is an organisation supporting the semiconductor industry worldwide. The SEMI F47 specification defines levels of input voltage sags with which a semiconductor tool must operate without interruption. For example, power supplies must be able to tolerate an input voltage drop of 50% of the nominal voltage for at least 200ms. Such voltage drops can occur when large loads start or during mains voltage switching. Compatibility with these requirements is also important for other industries. Only power supplies with state-of-the-art technologies fulfill the SEMI F47 requirements. Many PULS units are approved according to this standard and bear the “F47 Power Quality Star” approval mark.

## NEC Class 2

The NEC (National Electrical Code) is a North American standard which is regarded as the guideline for all electrical installations in the USA. NEC Class 2 defines voltage, current and power limits which are considered to be safe from a fire ignition standpoint and provide an acceptable protection against electric shock. An NEC Class 2 circuit has reduced requirements regarding wiring methods, insulation, wire size and over-current protection. Furthermore, the approval process of the end-application is much easier. NEC Class 2 circuits need to be powered from a listed NEC Class 2 power supply which ensures, that the output current is always below 8A and the output power is always below 100VA. These limits need to be fulfilled even under overload or during fault conditions of the unit. Extensive tests and approvals are necessary.

## RoHS

Restriction of the usage of hazardous substances

The European directive 2002/95/EC limits the maximum impurity levels of homogeneous materials such as lead, mercury, cadmium, chrome <sup>6+</sup>, polybrominated flame retardants PBB and PBDE for the use in electrical and electronic equipment. RoHS is the abbreviation for “Restriction of the use of certain hazardous substances in electrical and electronic equipment”. All items in this catalog conform to this standard.

## “PFC-Norm” EN 61000-3-2

Line current harmonic content.

Typically, the input current waveform is not sinusoidal due to the periodical peak charging of the input capacitor. In industrial environments, complying with EN 61000-3-2 is only necessary under special conditions. Complying to this standard can have some technical drawbacks, such as lower efficiency as well as some commercial aspects such as higher purchasing costs. Frequently, the user does not profit from fulfilling this standard, therefore, it is important to know whether it is mandatory to meet this standard for a specific application.

The EN 61000-3-2 is not mandatory when:

- the harmonic requirements are included in a product standard which applies to the end-product;
- the input power of the power supply is below 75W. The measurement of the harmonic input current allows averaging of the total load cycle including all breaks;
- the input power of the power supply is above 1000W;
- the power supply is connected to a mains below 220V;
- the power supply is used outside the European Union;
- the power supply is connected to a mains supply with its own transformer.

Such mains supplies are considered to be non-public.

Where individual self-contained items are installed in a rack or a case (e.g. power supplies, drive system) as an assembled piece of equipment, they are regarded to be individually connected to the mains. Alternatively, it is also permitted to assess the whole rack.

This short interpretation allows a rough guide for machine designers and system integrators. It is not comprehensive and does not replace studying the standard or an in-depth analysis of the individual application.

## Protection of 24V Branches with Circuit Breakers



Standard miniature circuit breakers (MCB's or UL1077 circuit breakers) are without doubt, one of the most efficient and economical ways to open circuits to faulty branches. MCB's are designed to protect wires and circuits. If the ampere value and the characteristics of the MCB are

adapted to the wire size used, the wiring is considered to be thermally safe regardless of whether the MCB opens or not. To avoid voltage dips and under-voltage situations in adjacent 24V branches which are supplied by the same source, a fast (magnetic) tripping of the MCB is desired. A quick shutdown within 10ms is necessary corresponding roughly to the ride-through time of PLC's. This requires power supplies with high current reserves and large output capacitors. Furthermore, the impedance of the faulty branch must be sufficiently small in order for the current to actually flow. The best current reserve in the power supply does not help if Ohm's law does not permit current flow. The table on the right shows typical test results of four frequently used power supplies. The test results reveal the max. wire length for a magnetic tripping depending on the wire cross section. If the use of a MCB does not bring the desired effect, an electronic circuit breaker should be used.

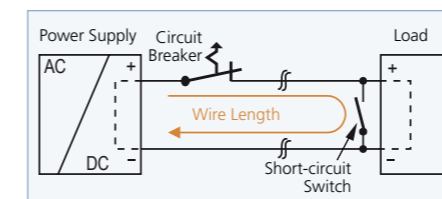

Test setup for tripping behaviour of circuit breakers. Don't forget that the distance to the load (= cable length) is usually half the total wire length (+ and - wire)!

Maximum wire length:

		0.75mm <sup>2</sup>	1.0mm <sup>2</sup>	1.5mm <sup>2</sup>	2.5mm <sup>2</sup>
<b>QS10.241 1-Phase 24V, 10A</b>					
<b>Circuit Breaker</b>	<b>C-2A</b>	20m	30m	46m	78m
	<b>C-3A</b>	17m	25m	33m	50m
	<b>C-4A</b>	11m	16m	21m	37m
	<b>C-6A</b>	5m	7m	11m	16m
	<b>C-8A</b>	2m	3m	4m	7m
	<b>C-10A</b>	1m	2m	3m	5m
	<b>B-6A</b>	13m	18m	26m	47m
	<b>B-10A</b>	4m	6m	10m	16m
<b>CS10.241 1-Phase 24V, 10A</b>					
<b>Circuit Breaker</b>	<b>C-2A</b>	21m	26m	37m	68m
	<b>C-3A</b>	15m	21m	30m	51m
	<b>C-4A</b>	10m	14m	20m	38m
	<b>C-6A</b>	4m	6m	9m	16m
	<b>C-8A</b>	1m	2m	4m	5,5m
	<b>C-10A</b>	1m	2m	3m	4m
	<b>B-6A</b>	13m	18m	26m	42m
	<b>B-10A</b>	4m	5m	9m	11m
<b>QS20.241 1-Phase 24V, 20A</b>					
<b>Circuit Breaker</b>	<b>C-2A</b>	26m	35m	62m	82m
	<b>C-3A</b>	23m	29m	54m	72m
	<b>C-4A</b>	15m	19m	31m	51m
	<b>C-6A</b>	7m	10m	15m	26m
	<b>C-8A</b>	5m	7m	10m	16m
	<b>C-10A</b>	2m	3m	5m	7m
	<b>B-6A</b>	19m	27m	38m	57m
	<b>B-10A</b>	7m	11m	14m	23m
<b>QT20.241 3-Phase 24V, 20A</b>					
<b>Circuit Breaker</b>	<b>C-2A</b>	24m	33m	44m	70m
	<b>C-3A</b>	21m	29m	39m	58m
	<b>C-4A</b>	13m	17m	27m	47m
	<b>C-6A</b>	3m	6m	8m	13m
	<b>C-8A</b>	1m	3m	4m	5m
	<b>C-10A</b>	0,5m	1m	2m	3m
	<b>B-6A</b>	18m	21m	33m	56m
	<b>B-10A</b>	3m	4m	6m	11m

## Power Supplies for DeviceNet® Systems

DeviceNet® is an open field bus which is used worldwide. This field bus is powered by two wires of a multi-core network cable. PULS supports the DeviceNet® system with two special power supplies. These two units are tested and approved according to the DeviceNet® Specification.

**QS5.DNET** 24V, 3.8A NEC-Class-2 power supply Page 14

**QS10.DNET** 24V, 8A NEC-Class-1 power supply Page 16

The special features of DeviceNet® power supplies:

- The nominal and overload currents are sized for the ratings of DeviceNet® cables.
- Large capacitors within the DeviceNet® network can be charged in the required time.
- After turn-on, the output voltage increases according to the DeviceNet® timing specification.
- The output voltage is adapted for the required DeviceNet® level.
- Our DeviceNet® power supplies are approved by the Open DeviceNet® Vendor Association (ODVA) and carry the approval mark "DeviceNet® Conformance Tested".

DeviceNet





## Characteristics of Semi-Regulated Power Supplies

Power supplies in the PULS DIMENSION X-Series have a new and innovative concept for generating a DC voltage from a three-phase input voltage. Principal applications of the X-Series include supplies to motors, valves and other load circuits with a high power consumption, where an accurate output voltage regulation (standard on switch mode power supplies) is not required.

### What does semi-regulated mean?

Transformer power supplies are normally unregulated. When the input voltage varies, the output voltage follows this change proportionally. Similar voltage fluctuations also occur when the load current changes. This is precisely where the semi-regulated concept used in the X-Series comes in. This series offers a stabilised output voltage in the core range of the input voltage (360 to 440Vac or 432 to 528Vac). The output voltage only starts to change proportionally with the input voltage if the input is outside of this core range. The minimum load requirement for a stabilised output is only 5% of the nominal load.

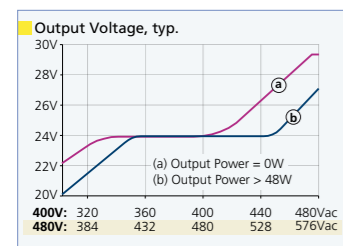

XT40: Output voltage versus input voltage and load current

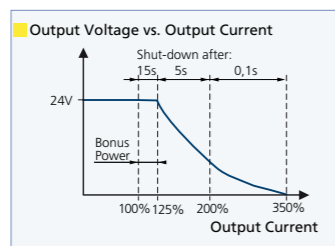

XT40: Large power reserves for dynamic consumers. A unit which has shut-down can be restarted with the reset button.

### Exploit potential cost savings

The advantages of the X-Series over its competitors include its lower purchase price, and smaller enclosures allowing further savings on the total system cost. In addition transport and installation costs are significantly reduced, energy costs are lower and the cooling and ventilation requirements are reduced. These are all factors that have not been available in this form until now.

### Available semi-regulated power supplies:

<b>XT40.241</b>	3x400Vac	24V, 40A	Page 25
<b>XT40.242</b>	3x480Vac	24V, 40A	Page 25
<b>XT40.361</b>	3x400Vac	36V, 26.6A	Page 26
<b>XT40.362</b>	3x480Vac	36V, 26.6A	Page 26
<b>XT40.481</b>	3x400Vac	48V, 20A	Page 27
<b>XT40.482</b>	3x480Vac	48V, 20A	Page 27
<b>XT40.721</b>	3x400Vac	72V, 13.3A	Page 27
<b>XT40.722</b>	3x480Vac	72V, 13.3A	Page 27

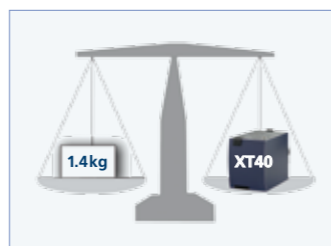

XT40: Weighing just 1.4 kg, the device provides 960 watts of continuous output power.



XT40: Easy diagnostic: The yellow LED reports overload, too low/high input voltage or a loss of a phase.

## Mains Voltages Worldwide

	100V / 200V	120V / 208V	120 / 240V	127V / 220V	220V / 380V	230V / 400V	240V / 415V	277V / 480V	440V	575V	600V
IEC 60038*)	•	•	•	•	•	•	•	•	•	•	•
Europe						•					
USA		•	•					•			
Canada			•							•	•
Japan	•										
China					•						
India						•			•		
Taiwan						•					
Russia						•					
South America				•							
Africa					•		•				

\*) IEC 60038: Norm regarding IEC standard voltages

## Conformal Coated Power Supplies

In environments where dust, contaminants, occasional high humidity, vibration or thermal shock can be expected, devices with conformal coated PC boards are recommended. A significantly higher operational safety level can be achieved by avoiding short circuits and corrosion of conductors and solder joints.

The protective coating is made with an acrylic varnish and the coating process is a dip method. Areas which are not allowed to be coated are protected by a mask (e.g. terminal blocks, fuses, potentiometers). The coating itself has no impact on the electrical performance of the power supply.

Above a certain order quantity, nearly all PULS power supplies can be equipped with conformal coating. Please contact your local PULS representative if you do not find the desired unit in the list below.

### Available power supplies with conformal coated PC board:

<b>ML50.109</b>	1-Ph-Input	24V, 2.1A	Page 13
<b>ML10.109</b>	1-Ph-Input	24V, 4.2A	Page 15
<b>CS5.241-C1</b>	1-Ph-Input	24V, 5A	Page 15
<b>QS10.241-C1</b>	1-Ph-Input	24V, 10A	Page 17
<b>QS20.241-C1</b>	1-Ph-Input	24V, 20A	Page 17
<b>SL10.309</b>	3-Ph-Input	24V, 10A	Page 24
<b>QT20.241-C1</b>	3-Ph-Input	24V, 20A	Page 24

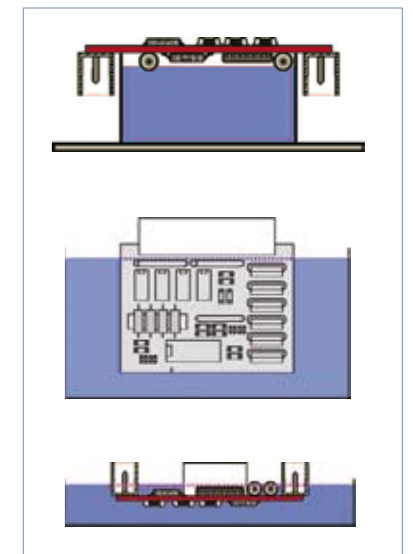

Dip coating process

Typical field applications are:

- Paper mills and paper processing industry which must be immune against all kinds of dust and electrostatic discharge.
- Railroads and construction machines with continuous vibrations and rapid temperature changes.
- Farms, where fumes (barns, silos, etc.) are present and resistance to insects is required.
- In protected outdoor areas, where moisture and condensation is occasionally present.
- Systems which are cooled with fans, resulting in extreme dust deposits.
- Subtropical regions with long lasting high humidity along with high ambient temperatures.
- Lighting, advertising displays and score boards which are located in protected outdoor areas.

## Series Connection of Outputs

Many power supplies are allowed to be connected together in series to achieve higher output voltages. Check the relevant product tables in this catalogue to see if a unit is suitable for series connection or not.

Please follow these instructions for series operation:

- Use only power supplies of the same type.
- It is possible to connect as many units in series as needed, providing the sum of the output voltages dose not exceed 150Vdc.
- Voltages with a potential above 60Vdc are not SELV and can be dangerous. Such voltages must be installed with suitable protection from touching.
- Note that leakage current, EMI, inrush current and harmonics will increase when using multiple power supplies.
- Avoid installing power supplies on top of each other and keep the recommended lateral installation clearances.

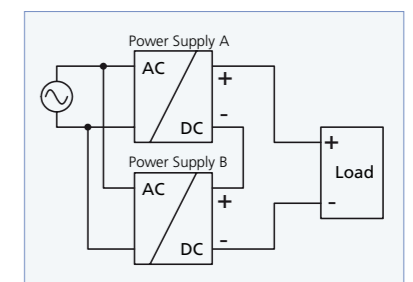

Series connection of outputs to achieve higher output voltages

## Parallel Use for Higher Output Power

### Parallel use to increase the output power

The paralleling of outputs for higher power needs is not permitted for all power supplies. Information as to which units are suitable for this purpose can be found in this catalogue in the relevant product tables. Only power supplies which are equipped with features to avoid a permanent overloading of one individual unit are suitable. Furthermore, the power supply is not allowed to enter into a "sleep mode" if a voltage is applied to the output terminals (which is automatically the case when units are connected in parallel). This could cause unexpected voltage dips when the load changes from a low level to a high level.

### Why are special product features necessary?

The unit with the higher output voltage will draw as much current as it can deliver. When it then switches from the voltage-regulation-mode to current-regulation-mode, the voltage reduces and the remaining current will be delivered by the second unit. The first unit can be permanently overloaded when there are no measures to prevent this. Since many power supplies offer extra current (PowerBoost), a thermal shut-down could occur. Exact adjustment of the output voltage only helps at first, when putting the system into operation. However, after a period of time the voltages will drift (aging and thermal effects) and current sharing will no longer takes place.

### Parallel use for 1+1 redundant systems or to deliver short term peak currents

For these purposes, there is no risk of a thermal overloading of one unit. All power supplies, even those which are not specified for parallel use in the product tables, can be used to build 1+1 redundant systems or to deliver short term peak current to the load when the average current is smaller than the current of one power supply. Please note that this is not valid for N+1 redundancy applications.

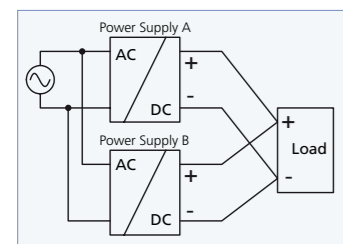

Parallel connection of outputs to achieve higher output power



Jumper to select between "single use" and "parallel use". Parallel use enables a current sharing between power supplies.

### Features of PULS power supplies to avoid overloading of one individual unit.

- **BonusPower®:**  
The BonusPower® feature includes a power manager which actively limits the duration in which the power supply can deliver more than the nominal current. Since the power supply is designed for this current, there is no risk to the unit.
- **Passive current balancing:**  
The passive current balancing feature can be activated by setting the single/parallel-use jumper into "parallel use". This feature is available on many units and results in a "soft" output characteristic. The output voltage at no load is a proximately 5% higher compared to full load. This allows the load current to be distributed equally between the individual units even when the output voltage is not adjusted to the exactly same value.
- **Active current balancing:**  
The active current balancing feature requires a current share bus on the power supply. This feature is only available on the SL40.301 unit. The current share signal terminal of all units must be linked together. An internal electronic circuit ensures exact current balancing.

### Instructions for using power supplies in parallel:

- Use only power supplies of the same family.
- It is possible to connect as many units in parallel as needed. A fuse (or diode) on the output is only required if more than three units are connected in parallel. This avoids that a defective unit can become a load for the functional units.
- Note that leakage current, EMI, inrush current and harmonics will increase when using multiple power supplies.
- Avoid installing power supplies on top of each other and keep the recommended lateral installation clearances.

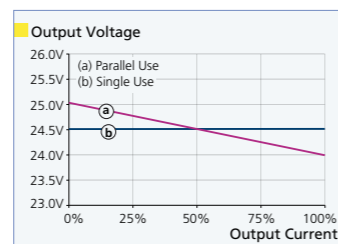

Parallel use: The output voltage at no load is approximately 5% higher compared to full load. The load current is distributed equally between the individual units.

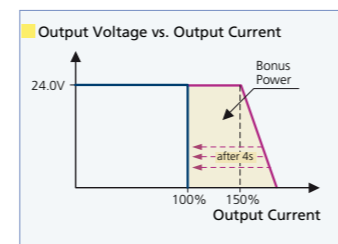

The BonusPower® will be automatically reduced to the nominal output power after 4s. This avoids a permanent overloading of one of the paralleled units.

## Mounting Accessories

No DIN-rail available? Is the cabinet too shallow?

Various mounting brackets are available for a direct wall or panel mounting of DIMENSION and SilverLine units. The mounting brackets ZM11.SIDE through to ZM15.SIDE are used to mount DIMENSION power supplies and other DIMENSION modules sideways to reduce the installation depth. All ordering numbers can be found in this catalogue in the product tables.



ZM1.WALL  
Designed for direct panel or wall mounting of DIMENSION units



SLZ10 ... SLZ14  
Mounting bracket for the S7-300 rail  
Bracket: Width of unit:  
SLZ10 up to 40mm  
SLZ11 41 to 51mm  
SLZ12 52 to 66mm  
SLZ13 67 to 90mm  
SLZ14 91 to 121mm



SLZ02  
Designed for direct panel or wall mounting of SilverLine units



ZM11.SIDE ... ZM15.SIDE  
Designed for sideways mounting of DIMENSION units. Can be used with or without DIN-rail



ZM2.WALL  
Mounting bracket for panel or wall mounting of the QS40, QT40 or XT40 units

## Using Only Two Legs of the Three-Phase System

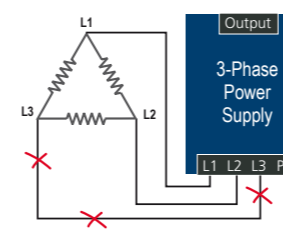

There is no problem if one phase fails. All three-phase power supplies are protected against a loss of one phase. External protection circuits such as motor protectors are not required. Many units are allowed to run permanently on only two legs. For high-power units, a reduction of the output power or the maximum ambient temperature is required when the unit is permanently used on only two legs. Exceeding these limits results in a thermal shut-down. The product tables of the individual units describe the maximum output power as a percentage to which a unit can be loaded when used on only two

legs. This percentage is valid for the entire input voltage and temperature range. More details can be found in the datasheet.

Please note: An operation on only two legs slightly increases the losses. The lifetime expectancy and the MTBF figures are minimally reduced. Furthermore, the input current will be approximately 1.8-times higher.

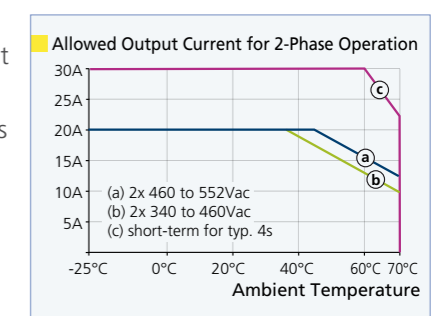

Allowed output power for 2-phase operation (example: QT20.241)

# FOOTNOTES

- 1) At nominal input voltage and nominal output load
  - 2) 50 Ohm measurement, bandwidth 20MHz
  - 3) At nominal load and the lower end of the input voltage range
  - 4) The given value describe the minimum required value of an external circuit breaker. If an external circuit breaker is required or not, can be found in the datasheet.
  - 5) Peak value and inrush energy at an ambient of 40°C and cold start
  - 6) According to SN 29500 (IEC 61709) and 230Vac (or 3x400Vac or nominal DC-voltage), nominal load and 40°C ambient temperature
  - 7) Depth without DIN-rail, dimensions without plug-connector
  - 8) Harmonic correction describes whether the input current waveform is electronically corrected (active) or smoothed with an inductor (passive) in order to reduce the amount of harmonic current. EN 61000-3-2 does not necessarily require a corrected unit.
  - 9) Valid only for the same units up to a total voltage of 150Vdc.
- 
- A) The values given describe as a percentage of the maximum output power to which the unit can be loaded when one phase fails. The value is valid for the entire input voltage and temperature range. More details can be found in the datasheet and on page 51.
  - B) The unit can respond with a thermal shut-down when continuously loaded with >120W and operated with a mains voltage of 100V or below.
  - C) Selectable between continuous current and FUSE Mode® (shut-down).
  - D) During overload, unit shuts down after the following time periods:
    - 15s for output currents between 100 and 125%
    - 5s for output currents between 125 and 200%
    - 100ms for output currents > 200%To restart, press the reset button or cycle the input power.
  - E) No inrush current surge thanks to capacitor-free input stage.
  - F) After turn-off, the output voltage decreases continuously. E.g.: after 3ms and full load, 80% of the nominal output voltage is available.
  - G) Do not use the short term current / power longer than a duty cycle of 10% and/or not longer than 1 minute every 10 minutes.
  - H) Once the short term power is exceeded, the power supply responds with a time-delayed shut-down.
  - J) The power supply should not be used in parallel in order to increase the output power. However, units can be paralleled for building 1+1 redundancy systems or to deliver short-term peak currents to the load when the average current is smaller than the current of one power supply.
  - K) BonusPower® operates for typ. 4s. After this, the output power will automatically be reduced to the continuous output power level.
  - L) The short-term power is continuously allowed up to an ambient of 45°C. Do not use the short term power longer than a duty cycle of 10% and / or not longer than 1 minute every 10 minutes above 45°C.
  - M) No passive current share. One or more units can be permanently overloaded, which shortens the lifetime expectancy and MTBF. The overloaded unit can respond with thermal shut-down at temperatures above 45°C.
  - N) Set unit into parallel mode by changing the jumper position. The regulation of the output voltage is then load dependent. The output voltage at no load is approximately 5% higher compared to full load. This enables a current share between paralleled units.
  - O) Open collector transistor output, 30mA max.
  - P) Relay contact: 60Vdc 0.3A; 30Vdc 1A; 30Vac 0.5A
  - R) Resistor with automatic bypass
  - S) Additional tests might be necessary when the complete system has to be approved according to UL 508 or UL60950-1.
  - T) A supply from the intermediate DC-bus of a frequency converter is not recommended and can cause a malfunction or damage the unit.
  - U) Use appropriate external fuses in the + and – line which are suitable for the DC-voltage (e.g. KLKD from Littelfuse).



## PULS GERMANY

### HEADQUARTERS

PULS GmbH  
Arabellastraße 15  
81925 Munich  
Tel. +49 89 9278-0  
Fax +49 89 9278-199  
contact-muc@pulspower.de  
www.pulspower.de



Your partner for  
customised solutions:  
**MGV Stromversorgungen GmbH**  
Member of the PULS group  
Tel. +49 89 678090-0  
info@mgv.de  
www.mgv.de

## PULS LOCAL OFFICES

**Austria**  
PULS Österreich  
Bernreit 26  
A-3163 Rohrbach  
Tel. +43 27 64 32 13  
Fax +43 27 64 32 66  
otto.schreiner@puls-power.at  
www.pulspower.at

**China**  
PULS Trading Co., Ltd  
No. 1 Rui' en Lane  
Xingpu Road  
215126 Suzhou Industrial Park  
P.R. China  
Tel +86 512 62881820  
Fax +86 512 62881806  
contact-sales-suzhou@pulspower.com  
www.pulspower.cn

**France**  
PULS SARL  
3 Rue du Jubin-Bât. 1  
F-69570 Dardilly  
Tel. +33 478 66 89 41  
Fax +33 478 35 27 92  
puls@pulspower.fr  
www.pulspower.fr

**Switzerland**  
PULS Electronic GmbH  
Lindenrain 2  
CH-5108 Oberflachs  
Tel. +41 56 450 18 10  
Fax +41 56 450 18 11  
info@puls-power.ch  
www.pulspower.ch

**UK United Kingdom**  
PULS UK Ltd  
Unit 10 Ampthill Business Park  
Ampthill  
Bedfordshire, MK45 2QW  
Tel. +44 845 130 1080  
Fax +44 845 130 1081  
sales@puls.co.uk  
www.pulspower.co.uk

**USA & North America**  
PULS L.P.  
2560 Foxfield Road  
St. Charles, IL 60174  
Tel. +1 630 587 9780  
Fax +1 630 587 9735  
info@puls-us.com  
www.pulspower.us

## PULS PARTNERS

**Australia**  
Control Logic Pty. Ltd.  
Tel. +61 7 3623 1212  
sales@control-logic.com.au  
www.control-logic.com.au

**Belgium**  
Elipse nv  
Tel. +32 3 354 5180  
info@elipse.eu  
www.elipse.eu

**Czech Republic**  
OEM Automatic, spol. r.o.  
Tel. +420 241 484 940  
info@oem-automatic.cz  
www.oem-automatic.cz

**Denmark**  
OEM Automatic Klitso  
Tel. +45 70 106400  
info@oemklitso.dk  
www.oemklitso.dk

**Estonia**  
OEM Automatic OU  
Tel. +372 655 0871  
info.ee@oem.fi  
www.oem.ee

**Finland / Baltic States**  
OEM Finland Oy  
Tel. +358 207 499 499  
info@oem.fi  
www.oem.fi

**Iceland**  
Samey  
Tel. +354 51052-00  
sala@samey.is  
www.samey.is

**Italy**  
Piero Bersanini S.p.A.  
Tel. +39 02 268531  
commerciale@pierothersanini.com  
www.pierothersanini.com

**Luxemburg**  
Elipse nv  
Tel. +32 3 354 5180  
info@elipse.eu  
www.elipse.eu

**Netherlands**  
Elipse nv  
Tel. 0800-3547738  
info@elipse.eu  
www.elipse.eu

**Norway**  
OEM Automatic AS  
Tel. +47 32 2105-05  
post@oem.no  
www.oem.no

**Poland**  
OEM Automatic Sp. z o.o.  
Tel. +48 22 86327-22  
info@pl.oem.se  
www.oemautomatic.com.pl

**Portugal**  
Electrónica Olfer, S.L.  
Tel. +351 91 7308 252  
portugal@olfer.com  
www.olfer.com

**Singapore**  
Futron Electronics PTE LTD.  
Tel. +65 6250 2456  
futron@singnet.com.sg  
www.futronelectronics.com.sg

**Slovakia**  
OEM Automatic, s.r.o.  
Tel. +421 911 122 009  
info@oem-automatic.sk  
www.oem.sk

**Slovenia**  
Robotina d.o.o.  
Tel. +386 5 68920-20  
info@robotina.si  
www.robotina.si

**South Africa**  
Current Automation  
Tel. +27 11 462-4253  
ca@switches.co.za  
www.rectifier.co.za

**Spain**  
Electrónica Olfer, S.L.  
Tel. +34 91 4840850  
info@olfer.com  
www.olfer.com

**Sweden**  
OEM Automatic AB  
Tel. +46 75 242 41 00  
info@aut.oem.se  
www.oemautomatic.se

**Turkey**  
Otes Elektronik Ltd. Sti.  
Tel. +90 216 337 7056  
info@otes.com.tr  
www.otes.com.tr

The information presented in this catalogue is believed to be accurate and reliable and may change without notice.  
All parameters are specified at the nominal input voltage, nominal output current, 25°C ambient and after a five minutes run-in time unless otherwise noted.

Products 2009-2010-EN-2 MP-300.001.16-10 B

Design by YELLOBEE www.yellobee.de  
EAST. WEST. DESIGN.

# PRODUCTS